

DESCRIPTION

Microsemi's new Powermite UPT series transient voltage suppressors feature oxide-passivated chips, with high-temperature solder bonds for high surge capability, and negligible electrical degradation under repeated surge conditions. Both unidirectional and bidirectional configurations are available.

In addition to its size advantages, Powermite package includes a full metallic bottom (cathode) that eliminates possibility of solder flux entrapment at assembly and a unique locking tab serving as an integral heat sink.

Innovative design makes this device fully compatible for use with automatic insertion equipment.

IMPORTANT: For the most current data, consult MICROSEMI's website: <http://www.microsemi.com>

APPEARANCE

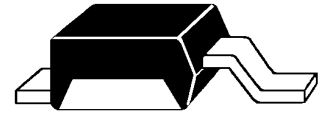

DO-216AA

FEATURES

- Powermite Package with standoff voltages 5 to 48 V
- Both Unidirectional polarities and Bidirectional:
Anode to case bottom (UPT5e3 thru UPT48e3)
Cathode to case bottom (UPT5Re3 thru UPT48Re3)
Bidirectional (UPTB8e3 thru UPTB48e3)
- Clamping time less than 100 pico-seconds for unidirectional
- Moisture classification is Level 1 with no dry pack required per IPC/JEDEC J-STD-020B
- RoHS Compliant with e3 suffix part number

APPLICATIONS / BENEFITS

- Protects sensitive components such as IC's, CMOS, Bipolar, BiCMOS, ECL, DTL, T²L, etc.
- Protection from switching transients & induced RF
- New improved lower leakage current for the UPT5Re3
- Integral heat sink / locking tabs
- Full metallic bottom eliminates flux entrapment
- Compliant to IEC61000-4-2 and IEC61000-4-4 for ESD and EFT protection respectively
- Secondary lightning protection per IEC61000-4-5 with 42 Ohms source impedance:
Class 1: UPT5//UPT5R/UPTB8 to17
Class 2: UPT5//UPT5R/UPTB8 to12
(also add e3 suffix to each part number)

MAXIMUM RATINGS

- Operating and Storage Temperature: -65°C to +150°C
- Peak Pulse Power at 8/20 μs (See Figure 1 and 2)
UPT5Re3: 600 Watts
UPT5e3 thru UPT48e3: 1000 Watts
UPT8Re3 thru UPT48Re3: 1000 Watts
UPTB8e3 thru UPTB48e3: 1000 Watts
- Peak Pulse Power at 10/1000 μs (See Figure 2).
UPT5Re3: 100 Watts
UPT5e3 thru UPT48e3: 150 Watts
UPT8Re3 thru UPT48Re3: 150 Watts
UPTB8e3 thru UPTB48e3: 150 Watts
- Impulse Repetition Rate (duty factor): 0.01%
- Thermal resistance: 15°C/W junction to base tab or 240°C/W junction to ambient when mounted on FR4 PC board with 1 oz copper
- Steady-State Power: 2.5 Watts (base tab ≤112°C)
- Solder Temperatures: 260°C for 10 s (maximum)

MECHANICAL AND PACKAGING

- CASE: Void-free transfer molded thermosetting epoxy compound meeting UL94V-0
- FINISH: Annealed matte-Tin plating over copper and readily solderable per MIL-STD-750, method 2026
- POLARITY: Cathode or anode to TAB 1 (bottom) as described in Marking below and Figure 5
- MARKING:
Anode to TAB 1: T plus the last two digits of part number, e.g. UPT5e3 is T05*, UPT12e3 is T12*
Cathode to TAB1: U plus last two digits of part number, e.g. UPT5Re3 is U05*, UPT12Re3 is U12*
Bipolar: B plus the last two digits of part number, e.g. UPTB8e3 is B08*, UPTB12e3 is B12*, etc.
Please note dot suffix (for e3 suffix)
- WEIGHT: 0.016 gram (approximate)
- See package dimension on last page
- Tape & Reel option: Standard per EIA-481-B using 12 mm tape with 3,000 per 7 inch reel or 12,000 per 13 inch reel (add TR7 or TR13 suffix to part number)

ELECTRICAL CHARACTERISTICS @ 25°C

DEVICE TYPE (add e3 suffix)		RATED STANDOFF VOLTAGE V_{WM}	MINIMUM BREAKDOWN VOLTAGE $V_{(BR)} @ 1 \text{ mA}$	MAXIMUM STANDBY CURRENT $I_D @ V_{WM}$	MAXIMUM PEAK PULSE CURRENT* I_{PP}	MAXIMUM CLAMPING VOLTAGE $V_C @ 10A^*$	MAXIMUM TEMP. COEFFICIENT of $V_{(BR)}$ $\alpha_{V(BR)}$
Unidirectional	Bi-directional	V	V	μA	A	V	%/°C
UPT5		5	6.0	50	89.4	9.5	.030
UPT5R		5	6.0	5	60	9.5	.030
UPT8 & UPT8R	UPTB8	8	9.0	2	62.1	13.7	.040
UPT10 & UPT10R	UPTB10	10	11.0	2	47.2	18.0	.045
UPT12 & UPT12R	UPTB12	12	13.8	1	40.3	21.6	.050
UPT15 & UPT15R	UPTB15	15	16.7	1	33.9	26.0	.055
UPT17 & UPT17R	UPTB17	17	19.0	1	30.8	29.2	.060
UPT24 & UPT24R	UPTB24	24	28.4	1	22.0	43.2	.070
UPT28 & UPT28R	UPTB28	28	31.0	1	19.2	47.8	.075
UPT33 & UPT33R	UPTB33	33	36.8	1	16.4	56.7	.080
UPT48 & UPT48R	UPTB48	48	54.0	1	11.2	84.3	.090

* See Figure 1 for I_{PP} waveform of 8/20 μs

SYMBOLS & DEFINITIONS

Symbol	Definition
$V_{(BR)}$	Breakdown Voltage: The minimum voltage the device will exhibit at a specified current.
V_{WM}	Working Peak Standoff Voltage: The maximum peak voltage that can be applied over the operating temperature range.
P_{PP}	Peak Pulse Power: The peak power that can be applied for a specified pulse width and waveform.
I_D	Standby Current: The maximum current that will flow at the specified voltage and temperature.
I_{PP}	Peak Pulse Current: The peak current that can be applied for a specified pulse width and waveform.
C	Capacitance: The capacitance in picofarads of the TVS as defined @ 0 volts at a frequency of 1 MHz.

OUTLINE AND CIRCUIT

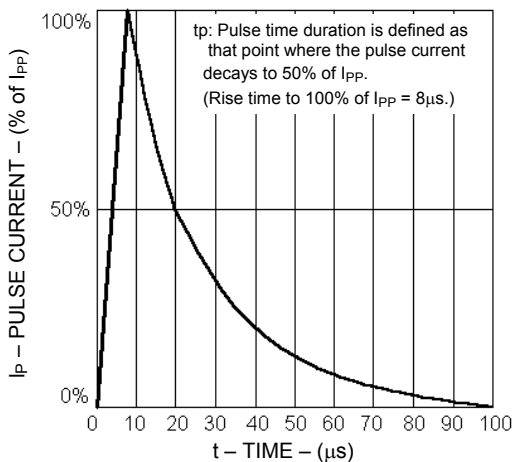

FIGURE 1
Pulse Waveform for Exponential Surge

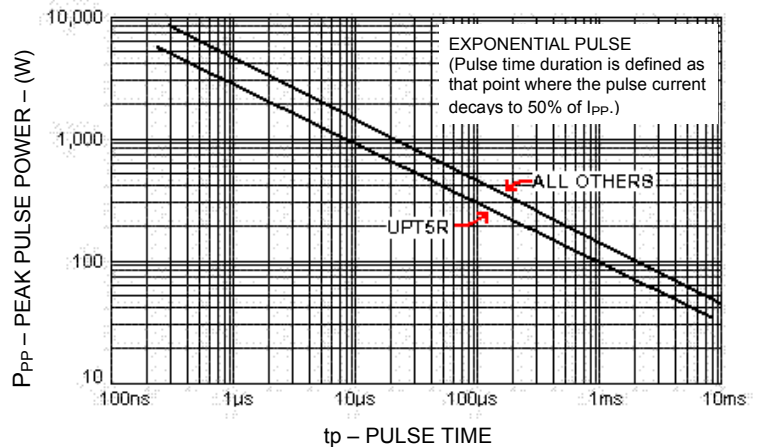

FIGURE 2
Peak Pulse Power vs. Pulse Duration

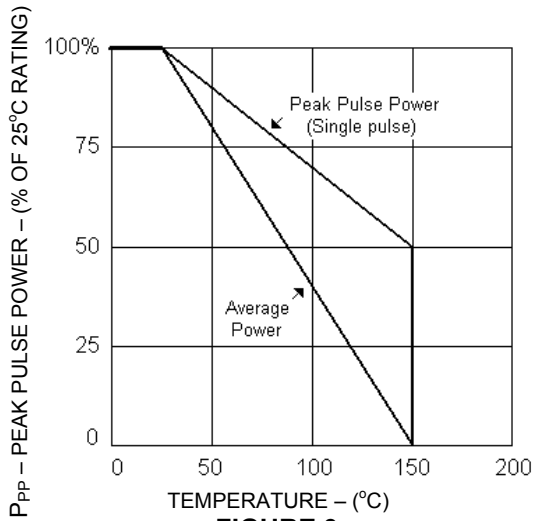

FIGURE 3
Derating Curve

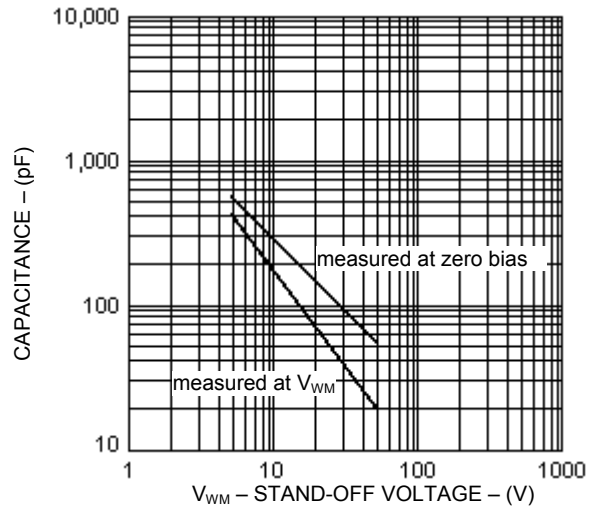
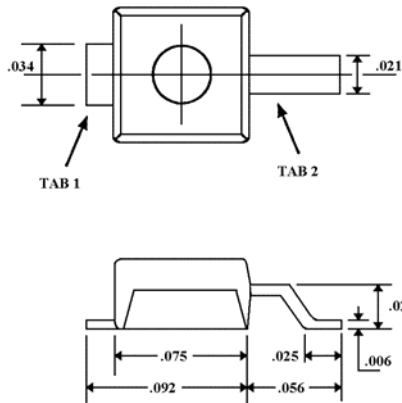

FIGURE 4
Typical Capacitance vs. Stand-Off Voltage

DIMENSIONS



All dimensions +/- .005 inches

FIGURE 5

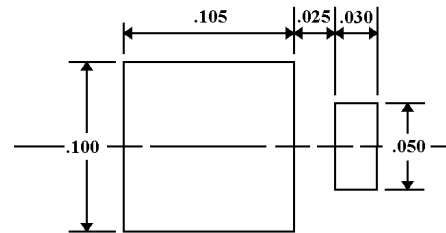

MOUNTING PAD in inches