

NGTB40N120FLWG

IGBT

This Insulated Gate Bipolar Transistor (IGBT) features a robust and cost effective Field Stop (FS) Trench construction, and provides superior performance in demanding switching applications, offering both low on state voltage and minimal switching loss. The IGBT is well suited for UPS and solar applications. Incorporated into the device is a soft and fast co-packaged free wheeling diode with a low forward voltage.

Features

- Low Saturation Voltage using NPT Trench with Field Stop Technology
- Low Switching Loss Reduces System Power Dissipation
- 10 μ s Short Circuit Capability
- Low Gate Charge
- Soft, Fast Free Wheeling Diode
- These are Pb-Free Devices

Typical Applications

- Solar Inverter
- UPS Inverter

ABSOLUTE MAXIMUM RATINGS

Rating	Symbol	Value	Unit
Collector-emitter voltage	V_{CES}	1200	V
Collector current @ $T_C = 25^\circ\text{C}$ @ $T_C = 100^\circ\text{C}$	I_C	80 40	A
Pulsed collector current, T_{pulse} limited by T_{Jmax}	I_{CM}	160	A
Diode forward current @ $T_C = 25^\circ\text{C}$ @ $T_C = 100^\circ\text{C}$	I_F	80 40	A
Diode pulsed current, T_{pulse} limited by T_{Jmax}	I_{FM}	160	A
Gate-emitter voltage Transient gate-emitter voltage ($T_{pulse} = 5 \mu\text{s}$, $D < 0.10$)	V_{GE}	± 20 ± 25	V
Power Dissipation @ $T_C = 25^\circ\text{C}$ @ $T_C = 100^\circ\text{C}$	P_D	260 104	W
Short Circuit Withstand Time $V_{GE} = 15 \text{ V}$, $V_{CE} = 500 \text{ V}$, $T_J \leq 150^\circ\text{C}$	T_{SC}	10	μs
Operating junction temperature range	T_J	-55 to +150	$^\circ\text{C}$
Storage temperature range	T_{stg}	-55 to +150	$^\circ\text{C}$
Lead temperature for soldering, 1/8" from case for 5 seconds	T_{SLD}	260	$^\circ\text{C}$

Stresses exceeding Maximum Ratings may damage the device. Maximum Ratings are stress ratings only. Functional operation above the Recommended Operating Conditions is not implied. Extended exposure to stresses above the Recommended Operating Conditions may affect device reliability.



ON Semiconductor®

<http://onsemi.com>

40 A, 1200 V
 $V_{CEsat} = 2.0 \text{ V}$
 $E_{off} = 1.6 \text{ mJ}$

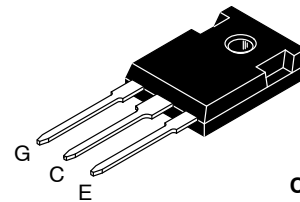
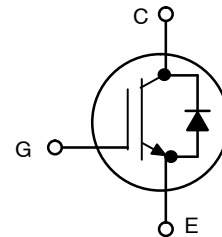

**TO-247
CASE 340L
STYLE 4**

MARKING DIAGRAM

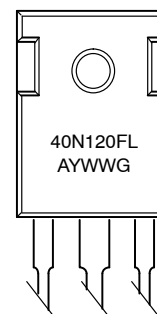

A = Assembly Location
Y = Year
WW = Work Week
G = Pb-Free Package

ORDERING INFORMATION

Device	Package	Shipping
NGTB40N120FLWG	TO-247 (Pb-Free)	30 Units / Rail

NGTB40N120FLWG

THERMAL CHARACTERISTICS

Rating	Symbol	Value	Unit
Thermal resistance junction-to-case, for IGBT	$R_{\theta JC}$	0.48	$^{\circ}\text{C}/\text{W}$
Thermal resistance junction-to-case, for Diode	$R_{\theta JC}$	1.5	$^{\circ}\text{C}/\text{W}$
Thermal resistance junction-to-ambient	$R_{\theta JA}$	40	$^{\circ}\text{C}/\text{W}$

ELECTRICAL CHARACTERISTICS ($T_J = 25^{\circ}\text{C}$ unless otherwise specified)

Parameter	Test Conditions	Symbol	Min	Typ	Max	Unit
-----------	-----------------	--------	-----	-----	-----	------

STATIC CHARACTERISTIC

Collector-emitter breakdown voltage, gate-emitter short-circuited	$V_{GE} = 0 \text{ V}, I_C = 500 \mu\text{A}$	$V_{(BR)CES}$	1200	-	-	V
Collector-emitter saturation voltage	$V_{GE} = 15 \text{ V}, I_C = 40 \text{ A}$ $V_{GE} = 15 \text{ V}, I_C = 40 \text{ A}, T_J = 150^{\circ}\text{C}$	V_{CEsat}	1.50 -	2.0 2.2	2.2 -	V
Gate-emitter threshold voltage	$V_{GE} = V_{CE}, I_C = 400 \mu\text{A}$	$V_{GE(th)}$	4.5	5.5	6.5	V
Collector-emitter cut-off current, gate-emitter short-circuited	$V_{GE} = 0 \text{ V}, V_{CE} = 1200 \text{ V}$ $V_{GE} = 0 \text{ V}, V_{CE} = 1200 \text{ V}, T_J = 150^{\circ}\text{C}$	I_{CES}	- -	- -	1.0 2	mA
Gate leakage current, collector-emitter short-circuited	$V_{GE} = 20 \text{ V}, V_{CE} = 0 \text{ V}$	I_{GES}	-	-	200	nA

DYNAMIC CHARACTERISTIC

Input capacitance	$V_{CE} = 20 \text{ V}, V_{GE} = 0 \text{ V}, f = 1 \text{ MHz}$	C_{ies}	-	10,000	-	pF
Output capacitance		C_{oes}	-	240	-	
Reverse transfer capacitance		C_{res}	-	180	-	
Gate charge total	$V_{CE} = 600 \text{ V}, I_C = 40 \text{ A}, V_{GE} = 15 \text{ V}$	Q_g	-	415	-	nC
Gate to emitter charge		Q_{ge}	-	80	-	
Gate to collector charge		Q_{gc}	-	170	-	

SWITCHING CHARACTERISTIC, INDUCTIVE LOAD

Turn-on delay time	$T_J = 25^{\circ}\text{C}$ $V_{CC} = 600 \text{ V}, I_C = 40 \text{ A}$ $R_g = 10 \Omega$ $V_{GE} = 0 \text{ V} / 15 \text{ V}$	$t_{d(on)}$	-	130	-	ns
Rise time		t_r	-	41	-	
Turn-off delay time		$t_{d(off)}$	-	385	-	
Fall time		t_f	-	140	-	
Turn-on switching loss		E_{on}	-	2.6	-	mJ
Turn-off switching loss		E_{off}	-	1.6	-	
Total switching loss		E_{ts}	-	4.2	-	
Turn-on delay time	$T_J = 125^{\circ}\text{C}$ $V_{CC} = 600 \text{ V}, I_C = 40 \text{ A}$ $R_g = 10 \Omega$ $V_{GE} = 0 \text{ V} / 15 \text{ V}$	$t_{d(on)}$	-	130	-	ns
Rise time		t_r	-	42	-	
Turn-off delay time		$t_{d(off)}$	-	400	-	
Fall time		t_f	-	230	-	
Turn-on switching loss		E_{on}	-	3.0	-	mJ
Turn-off switching loss		E_{off}	-	2.8	-	
Total switching loss		E_{ts}	-	5.8	-	

NGTB40N120FLWG

ELECTRICAL CHARACTERISTICS ($T_J = 25^\circ\text{C}$ unless otherwise specified)

Parameter	Test Conditions	Symbol	Min	Typ	Max	Unit
DIODE CHARACTERISTIC						
Forward voltage	$V_{GE} = 0\text{ V}, I_F = 40\text{ A}$ $V_{GE} = 0\text{ V}, I_F = 40\text{ A}, T_J = 150^\circ\text{C}$	V_F	– –	2.7 3.5	3.5	V
Reverse recovery time	$T_J = 25^\circ\text{C}$ $I_F = 40\text{ A}, V_R = 400\text{ V}$ $di_F/dt = 200\text{ A}/\mu\text{s}$	t_{rr}	–	200	–	ns
Reverse recovery charge		Q_{rr}	–	1.5	–	μC
Reverse recovery current		I_{rrm}	–	15	–	A
Reverse recovery time	$T_J = 125^\circ\text{C}$ $I_F = 40\text{ A}, V_R = 400\text{ V}$ $di_F/dt = 200\text{ A}/\mu\text{s}$	t_{rr}	–	260	–	ns
Reverse recovery charge		Q_{rr}	–	2.0	–	μC
Reverse recovery current		I_{rrm}	–	22	–	A

NGTB40N120FLWG

TYPICAL CHARACTERISTICS

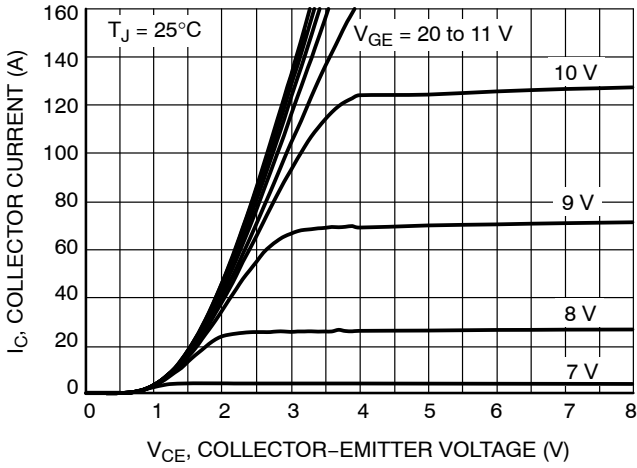

Figure 1. Output Characteristics

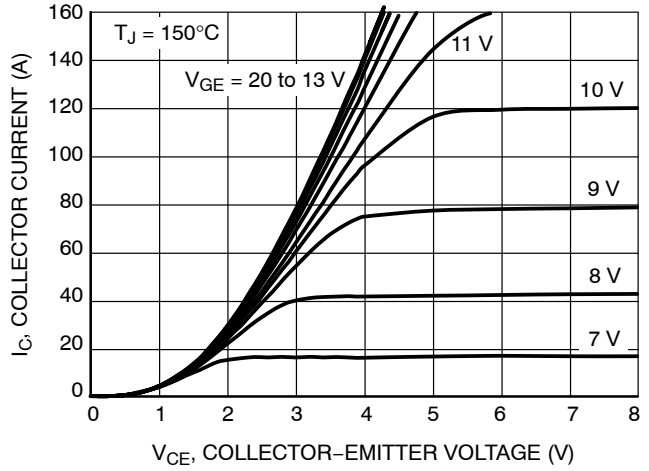

Figure 2. Output Characteristics

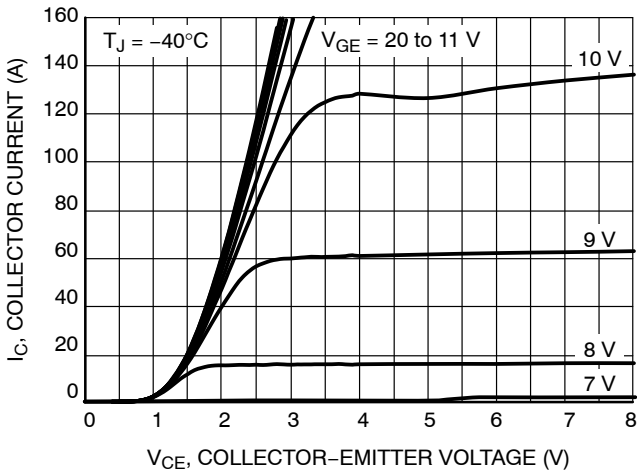

Figure 3. Output Characteristics

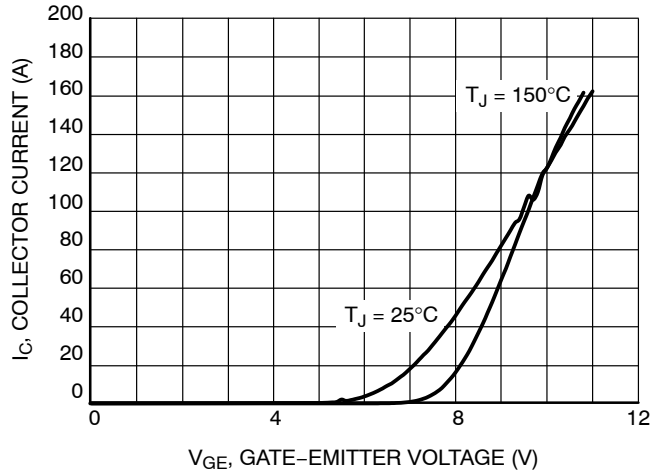

Figure 4. Typical Transfer Characteristics

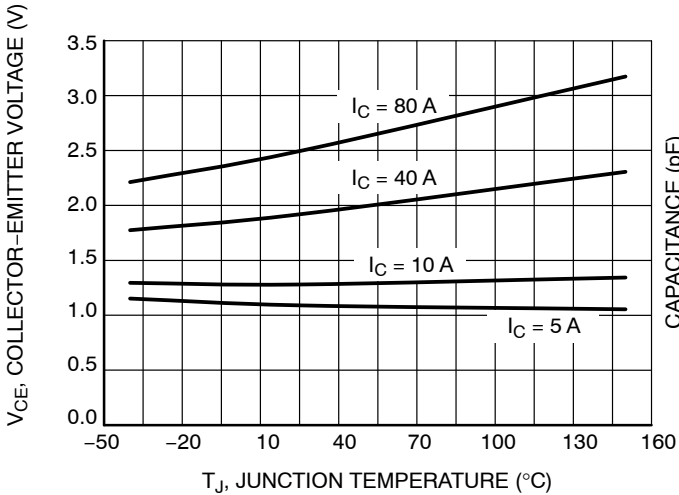

Figure 5. $V_{CE(sat)}$ vs. T_J

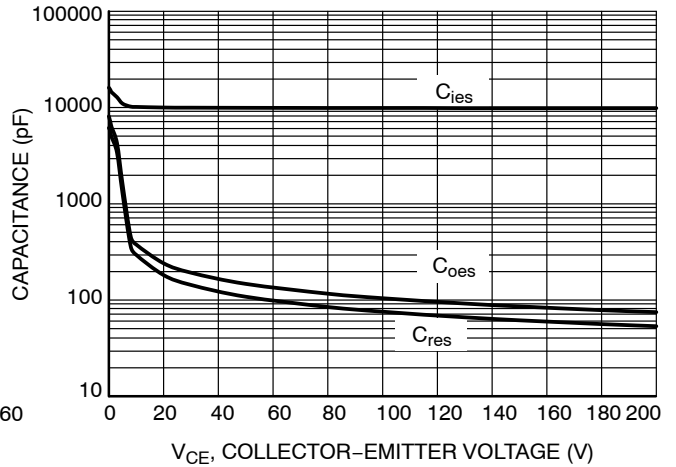

Figure 6. Typical Capacitance

NGTB40N120FLWG

TYPICAL CHARACTERISTICS

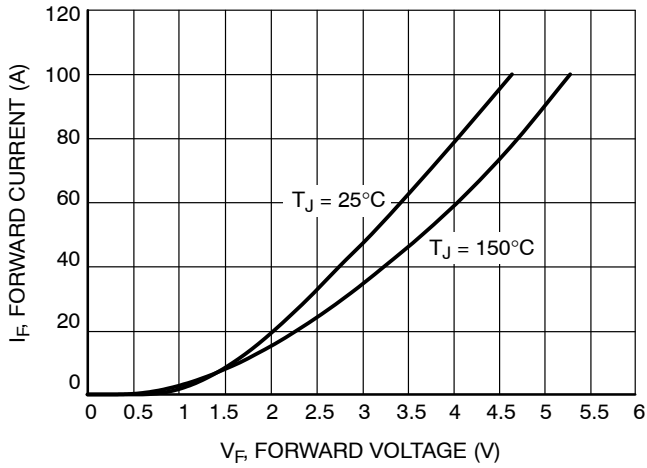

Figure 7. Diode Forward Characteristics

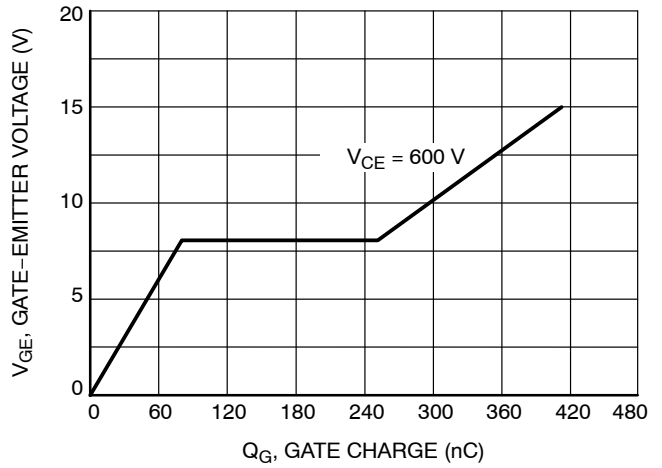

Figure 8. Typical Gate Charge

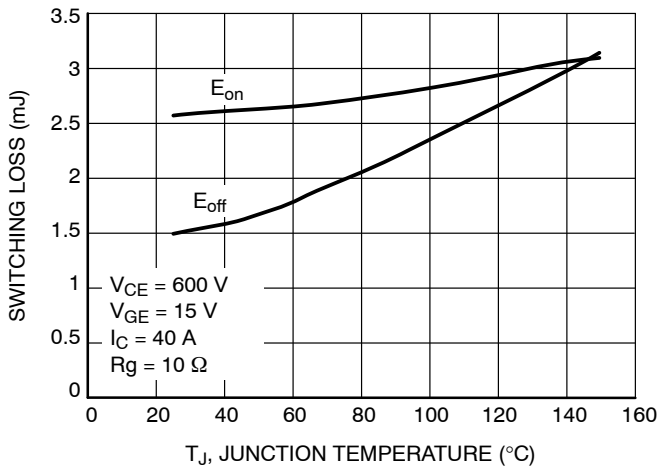

Figure 9. Switching Loss vs. Temperature

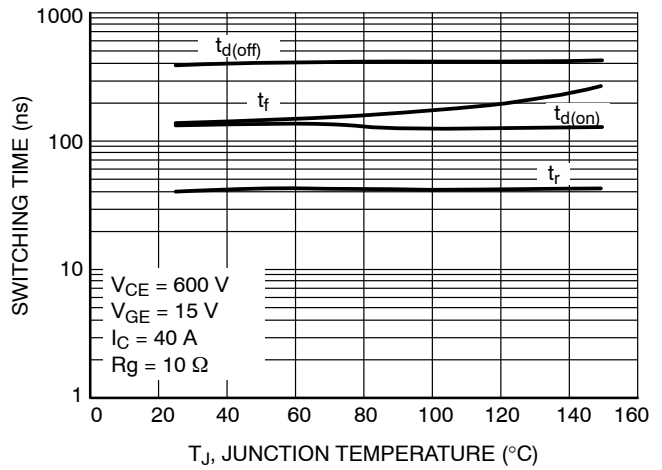

Figure 10. Switching Time vs. Temperature

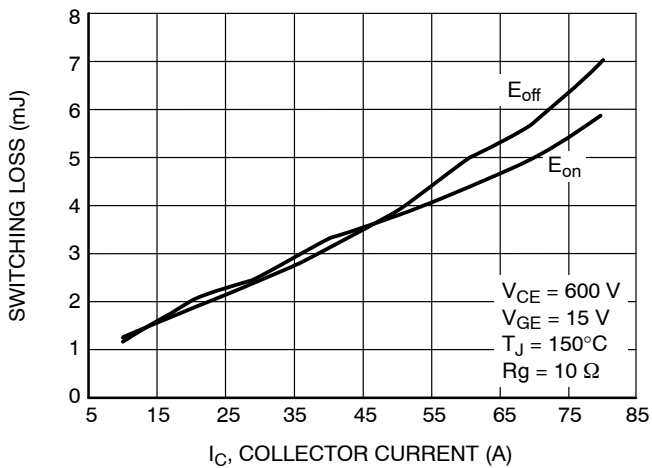

Figure 11. Switching Loss vs. I_C

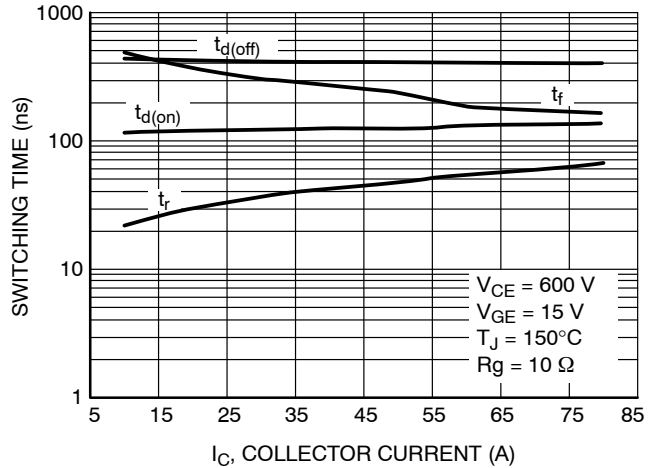

Figure 12. Switching Time vs. I_C

NGTB40N120FLWG

TYPICAL CHARACTERISTICS

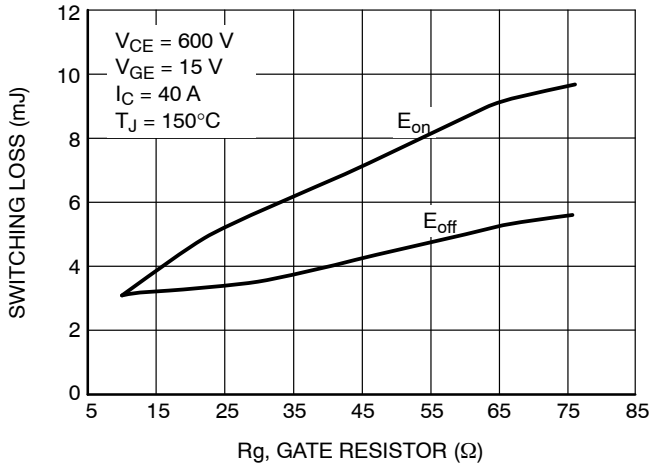

Figure 13. Switching Loss vs. Rg

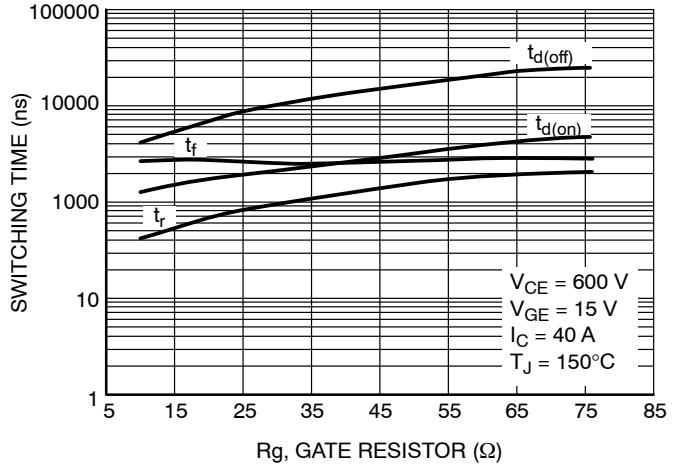

Figure 14. Switching Time vs. Rg

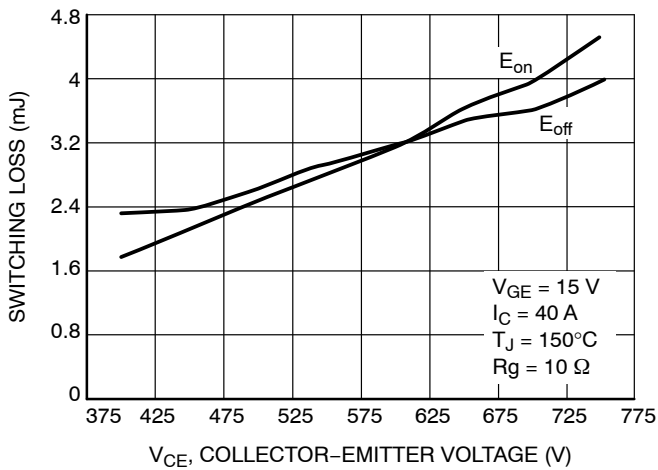

Figure 15. Switching Loss vs. V_{CE}

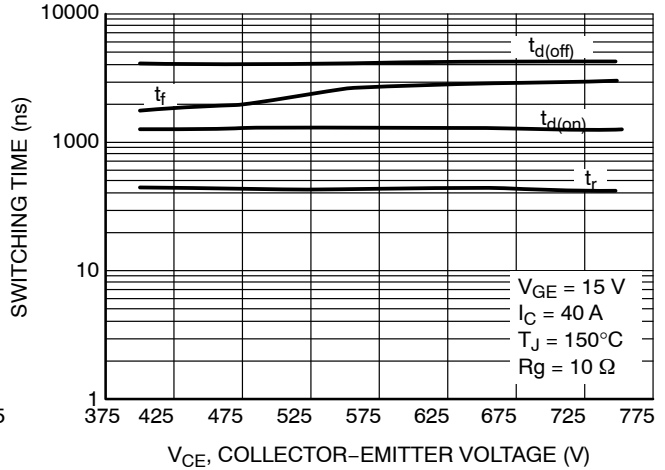

Figure 16. Switching Time vs. V_{CE}

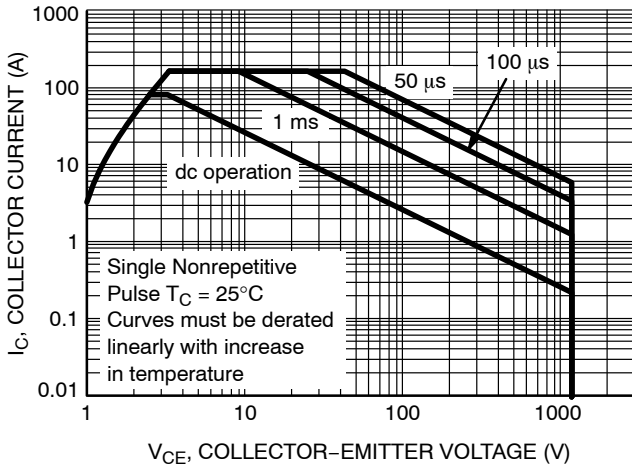

Figure 17. Safe Operating Area

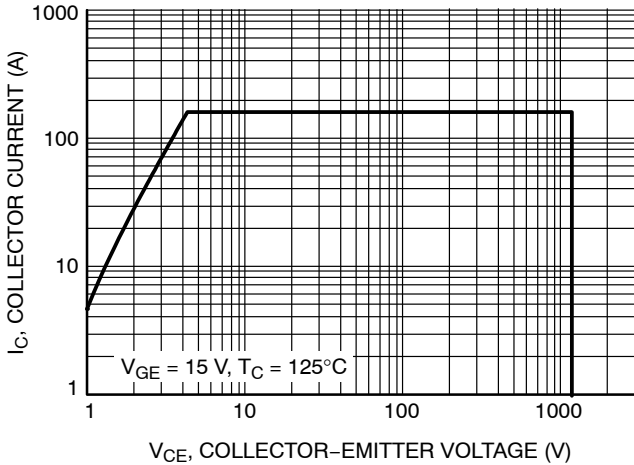

Figure 18. Reverse Bias Safe Operating Area

NGTB40N120FLWG

TYPICAL CHARACTERISTICS

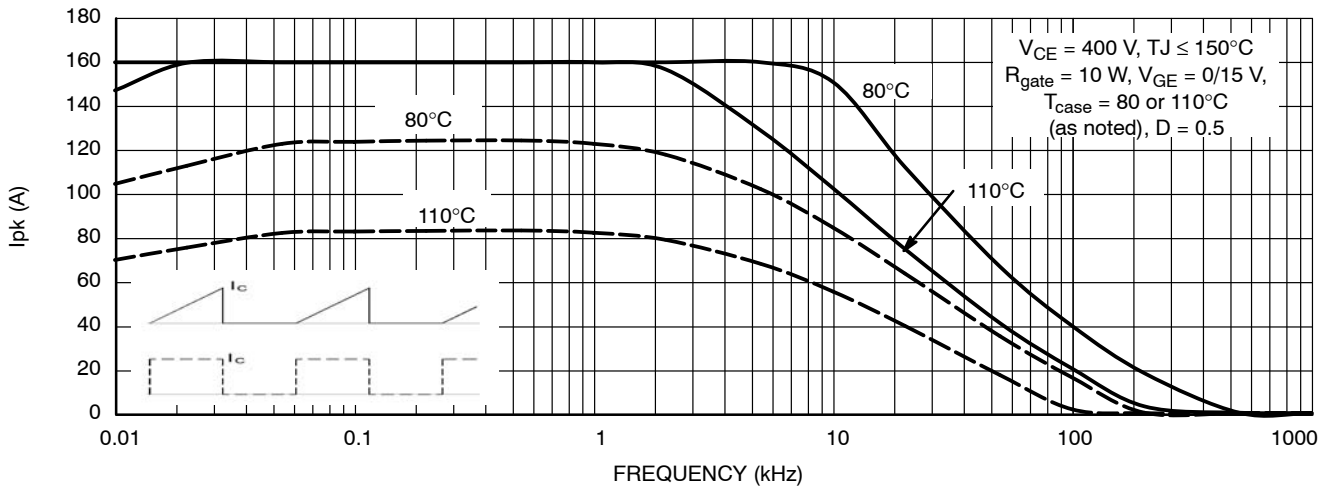

Figure 19. Collector Current vs. Switching Frequency

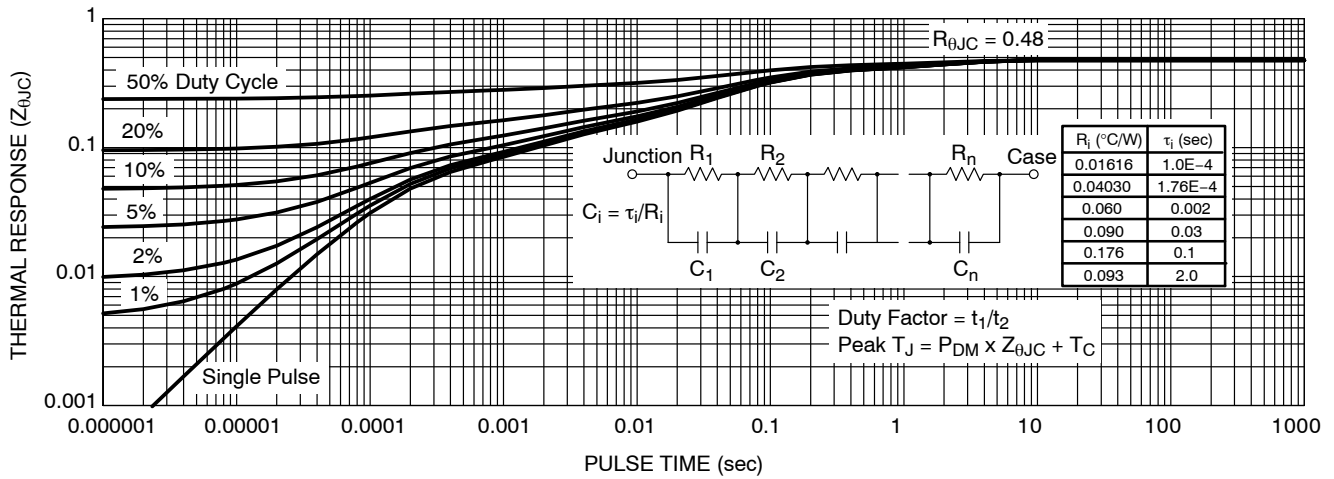

Figure 20. IGBT Transient Thermal Impedance

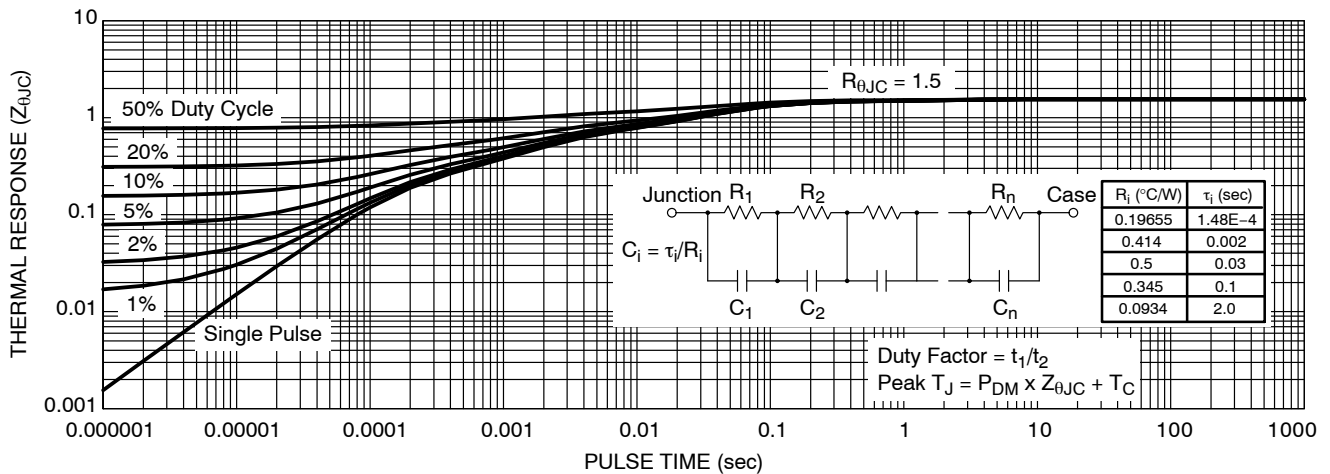

Figure 21. Diode Transient Thermal Impedance

NGTB40N120FLWG

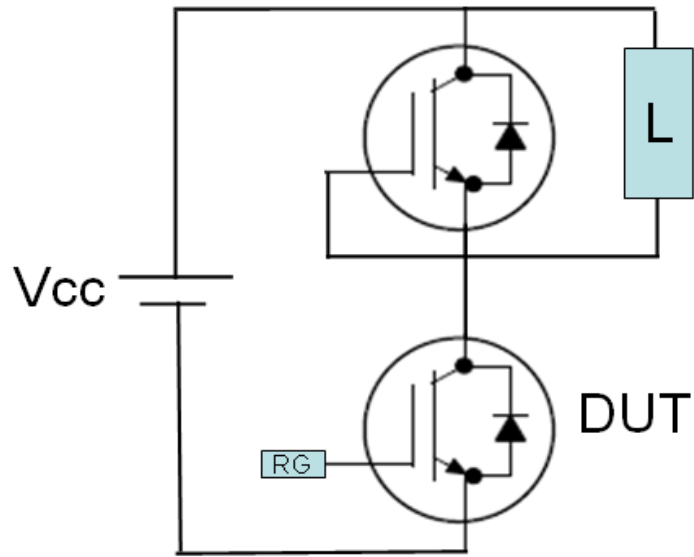

Figure 22. Test Circuit for Switching Characteristics

NGTB40N120FLWG

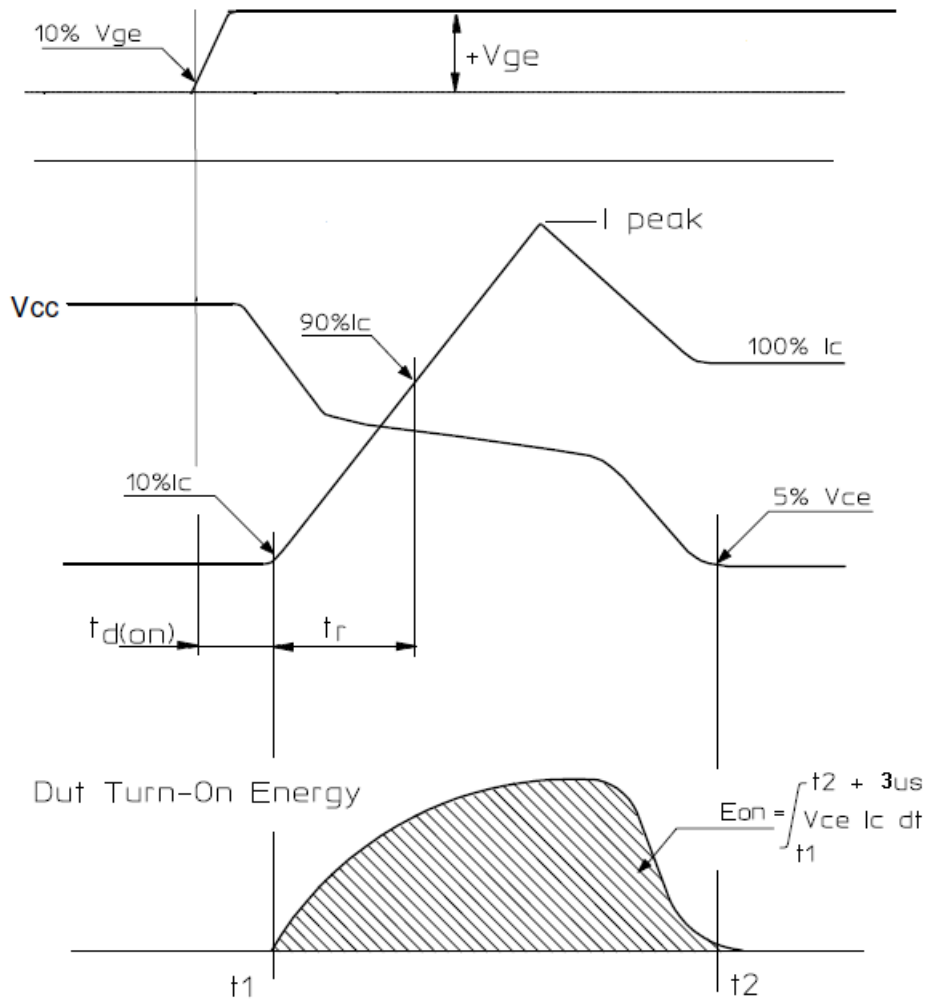

Figure 23. Definition of Turn On Waveform

NGTB40N120FLWG

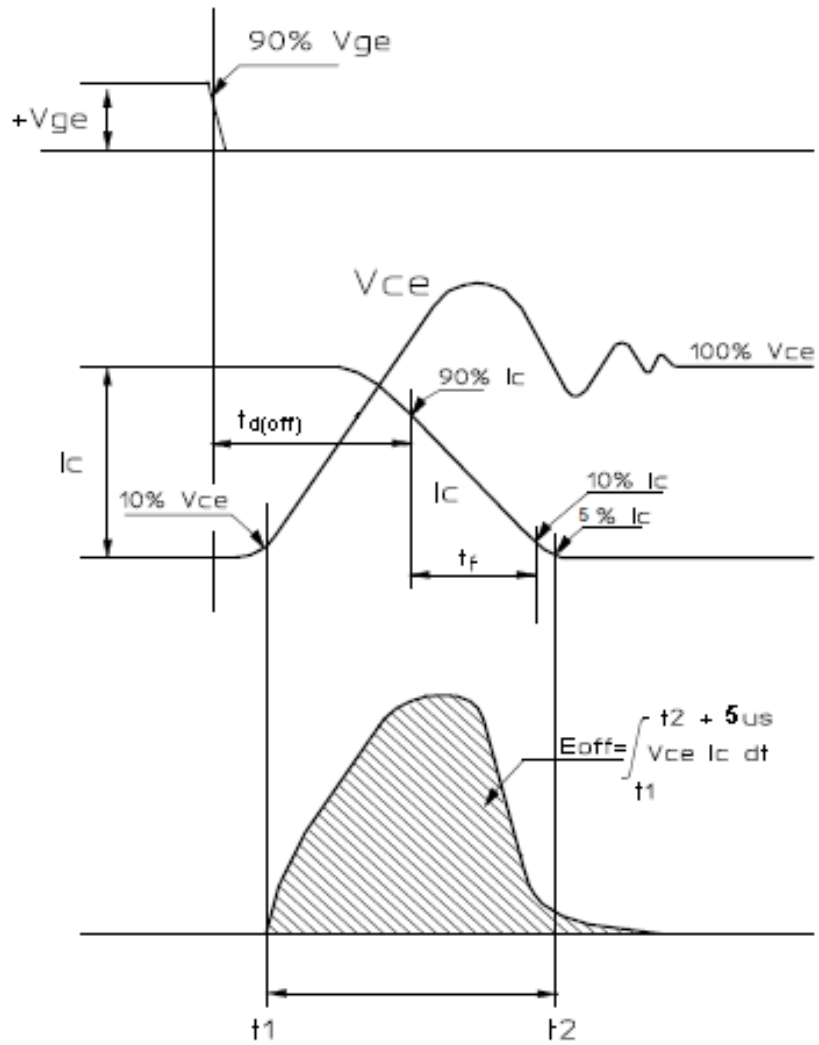
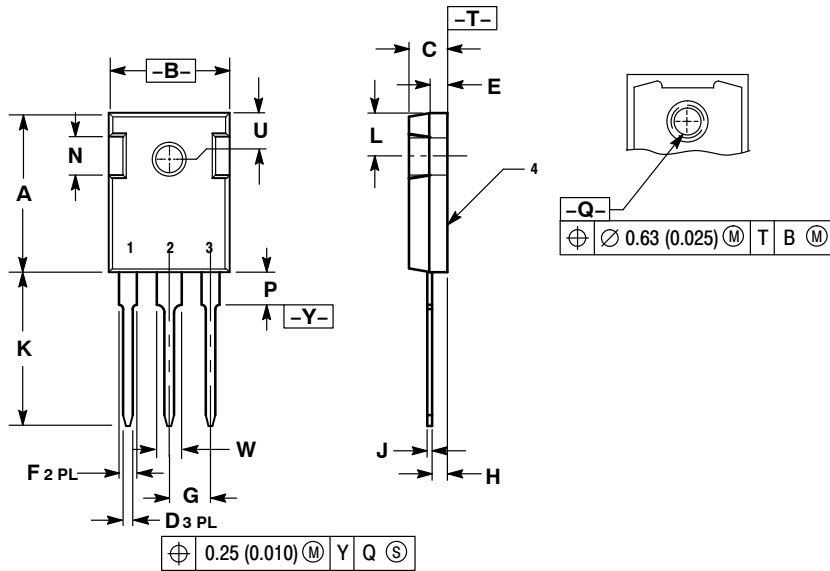

Figure 24. Definition of Turn Off Waveform

NGTB40N120FLWG

PACKAGE DIMENSIONS

TO-247
CASE 340L-02
ISSUE F



- NOTES:
1. DIMENSIONING AND TOLERANCING PER ANSI Y14.5M, 1982.
2. CONTROLLING DIMENSION: MILLIMETER.

DIM	MILLIMETERS		INCHES	
	MIN	MAX	MIN	MAX
A	20.32	21.08	0.800	0.830
B	15.75	16.26	0.620	0.640
C	4.70	5.30	0.185	0.209
D	1.00	1.40	0.040	0.055
E	1.90	2.60	0.075	0.102
F	1.65	2.13	0.065	0.084
G	5.45 BSC		0.215 BSC	
H	1.50	2.49	0.059	0.098
J	0.40	0.80	0.016	0.031
K	19.81	20.83	0.780	0.820
L	5.40	6.20	0.212	0.244
N	4.32	5.49	0.170	0.216
P	---	4.50	---	0.177
Q	3.55	3.65	0.140	0.144
U	6.15 BSC		0.242 BSC	
W	2.87	3.12	0.113	0.123

- STYLE 4:
PIN 1. GATE
2. COLLECTOR
3. EMITTER
4. COLLECTOR

ON Semiconductor and are registered trademarks of Semiconductor Components Industries, LLC (SCILLC). SCILLC owns the rights to a number of patents, trademarks, copyrights, trade secrets, and other intellectual property. A listing of SCILLC's product/patent coverage may be accessed at www.onsemi.com/site/pdf/Patent-Marking.pdf. SCILLC reserves the right to make changes without further notice to any products herein. SCILLC makes no warranty, representation or guarantee regarding the suitability of its products for any particular purpose, nor does SCILLC assume any liability arising out of the application or use of any product or circuit, and specifically disclaims any and all liability, including without limitation special, consequential or incidental damages. "Typical" parameters which may be provided in SCILLC data sheets and/or specifications can and do vary in different applications and actual performance may vary over time. All operating parameters, including "Typicals" must be validated for each customer application by customer's technical experts. SCILLC does not convey any license under its patent rights nor the rights of others. SCILLC products are not designed, intended, or authorized for use as components in systems intended for surgical implant into the body, or other applications intended to support or sustain life, or for any other application in which the failure of the SCILLC product could create a situation where personal injury or death may occur. Should Buyer purchase or use SCILLC products for any such unintended or unauthorized application, Buyer shall indemnify and hold SCILLC and its officers, employees, subsidiaries, affiliates, and distributors harmless against all claims, costs, damages, and expenses, and reasonable attorney fees arising out of, directly or indirectly, any claim of personal injury or death associated with such unintended or unauthorized use, even if such claim alleges that SCILLC was negligent regarding the design or manufacture of the part. SCILLC is an Equal Opportunity/Affirmative Action Employer. This literature is subject to all applicable copyright laws and is not for resale in any manner.

PUBLICATION ORDERING INFORMATION

LITERATURE FULFILLMENT:
Literature Distribution Center for ON Semiconductor
P.O. Box 5163, Denver, Colorado 80217 USA
Phone: 303-675-2175 or 800-344-3860 Toll Free USA/Canada
Fax: 303-675-2176 or 800-344-3867 Toll Free USA/Canada
Email: orderlit@onsemi.com

N. American Technical Support: 800-282-9855 Toll Free
USA/Canada
Europe, Middle East and Africa Technical Support:
Phone: 421 33 790 2910
Japan Customer Focus Center
Phone: 81-3-5817-1050

ON Semiconductor Website: www.onsemi.com
Order Literature: <http://www.onsemi.com/orderlit>
For additional information, please contact your local Sales Representative

NGTB40N120FLW/D