

TrenchHV™ Power MOSFET HiperFET™

IXFH150N17T

$V_{DSS} = 175V$
 $I_{D25} = 150A$
 $R_{DS(on)} \leq 12m\Omega$

N-Channel Enhancement Mode
Avalanche Rated



TO-247

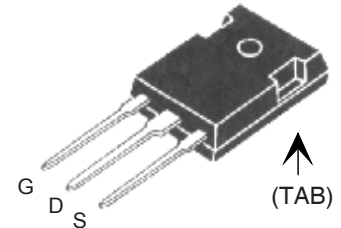

G = Gate D = Drain
 S = Source TAB = Drain

Symbol	Test Conditions	Maximum Ratings	
V_{DSS}	$T_J = 25^\circ C$ to $175^\circ C$	175	V
V_{DGR}	$T_J = 25^\circ C$ to $175^\circ C$, $R_{GS} = 1M\Omega$	175	V
V_{GSM}	Transient	± 30	V
I_{D25}	$T_C = 25^\circ C$	150	A
I_{LRMS}	Lead Current Limit, RMS	75	A
I_{DM}	$T_C = 25^\circ C$, pulse width limited by T_{JM}	400	A
I_A	$T_C = 25^\circ C$	75	A
E_{AS}	$T_C = 25^\circ C$	1.5	J
dV/dt	$I_S \leq I_{DM}$, $V_{DD} \leq V_{DSS}$, $T_J \leq 175^\circ C$	15	V/ns
P_D	$T_C = 25^\circ C$	830	W
T_J		-55 ... +175	$^\circ C$
T_{JM}		175	$^\circ C$
T_{stg}		-55 ... +175	$^\circ C$
T_L	1.6mm (0.062in.) from case for 10s	300	$^\circ C$
T_{sold}	Plastic body for 10 seconds	260	$^\circ C$
M_d	Mounting torque	1.13 / 10	Nm/lb.in.
Weight		6	g

Features

- International standard package
- Avalanche rated
- $175^\circ C$ Operating Temperature
- High current handling capability

Advantages

- Easy to mount
- Space savings
- High power density

Applications

- DC-DC converters
- Battery chargers
- Switched-mode and resonant-mode power supplies
- DC choppers
- AC motor drives
- Uninterruptible power supplies
- High speed power switching applications
- Synchronous rectification

Symbol	Test Conditions ($T_J = 25^\circ C$ unless otherwise specified)	Characteristic Values		
		Min.	Typ.	Max.
BV_{DSS}	$V_{GS} = 0V$, $I_D = 250\mu A$	175		V
$V_{GS(th)}$	$V_{DS} = V_{GS}$, $I_D = 3mA$	2.5		5.0 V
I_{GSS}	$V_{GS} = \pm 20V$, $V_{DS} = 0V$			± 200 nA
I_{DSS}	$V_{DS} = V_{DSS}$			5 μA
	$V_{GS} = 0V$ $T_J = 150^\circ C$		250	μA
$R_{DS(on)}$	$V_{GS} = 10V$, $I_D = 0.5 \cdot I_{D25}$, Notes 1	10	12	m Ω

Symbol	Test Conditions ($T_J = 25^\circ\text{C}$, unless otherwise specified)	Characteristic Values		
		Min.	Typ.	Max.
g_{fs}	$V_{DS} = 10\text{V}, I_D = 60\text{A}$, Note 1	75	118	S
C_{iss}	$V_{GS} = 0\text{V}, V_{DS} = 25\text{V}, f = 1\text{MHz}$		9800	pF
C_{oss}			1110	pF
C_{rss}			60	pF
$t_{d(on)}$	Resistive Switching Times $V_{GS} = 10\text{V}, V_{DS} = 0.5 \cdot V_{DSS}, I_D = 0.5 \cdot I_{D25}$ $R_G = 2\Omega$ (External)		22	ns
t_r			30	ns
$t_{d(off)}$			58	ns
t_f			30	ns
$Q_{g(on)}$	$V_{GS} = 10\text{V}, V_{DS} = 0.5 \cdot V_{DSS}, I_D = 25\text{A}$		155	nC
Q_{gs}			40	nC
Q_{gd}			47	nC
R_{thJC}			0.18	$^\circ\text{C/W}$
R_{thCH}		0.21		$^\circ\text{C/W}$

Source-Drain Diode

Symbol	Test Conditions ($T_J = 25^\circ\text{C}$, unless otherwise specified)	Characteristic Values		
		Min.	Typ.	Max.
I_S	$V_{GS} = 0\text{V}$			150 A
I_{SM}	Repetitive, Pulse width limited by T_{JM}			400 A
V_{SD}	$I_F = 50\text{A}, V_{GS} = 0\text{V}$, Note 1			1.2 V
t_{rr}	$I_F = 75\text{A}, V_{GS} = 0\text{V}$ $-di/dt = 200\text{A}/\mu\text{s}$ $V_R = 85\text{V}$		96	ns
I_{RM}			0.65	A
Q_{RM}			13.5	nC

Note 1: Pulse test, $t \leq 300\mu\text{s}$; duty cycle, $d \leq 2\%$.

TO-247 (IXFH) Outline

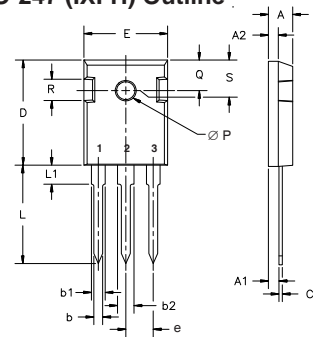

Terminals: 1 - Gate 2 - Drain

Dim.	Millimeter		Inches	
	Min.	Max.	Min.	Max.
A	4.7	5.3	.185	.209
A ₁	2.2	2.54	.087	.102
A ₂	2.2	2.6	.059	.098
b	1.0	1.4	.040	.055
b ₁	1.65	2.13	.065	.084
b ₂	2.87	3.12	.113	.123
C	.4	.8	.016	.031
D	20.80	21.46	.819	.845
E	15.75	16.26	.610	.640
e	5.20	5.72	0.205	0.225
L	19.81	20.32	.780	.800
L1		4.50		.177
∅P	3.55	3.65	.140	.144
Q	5.89	6.40	0.232	0.252
R	4.32	5.49	.170	.216

IXYS reserves the right to change limits, test conditions, and dimensions.

IXYS MOSFETs and IGBTs are covered by one or more of the following U.S. patents:

4,835,592	4,931,844	5,049,961	5,237,481	6,162,665	6,404,065 B1	6,683,344	6,727,585	7,005,734 B2	7,157,338B2
4,850,072	5,017,508	5,063,307	5,381,025	6,259,123 B1	6,534,343	6,710,405 B2	6,759,692	7,063,975 B2	
4,881,106	5,034,796	5,187,117	5,486,715	6,306,728 B1	6,583,505	6,710,463	6,771,478 B2	7,071,537	

Fig. 1. Output Characteristics @ 25°C

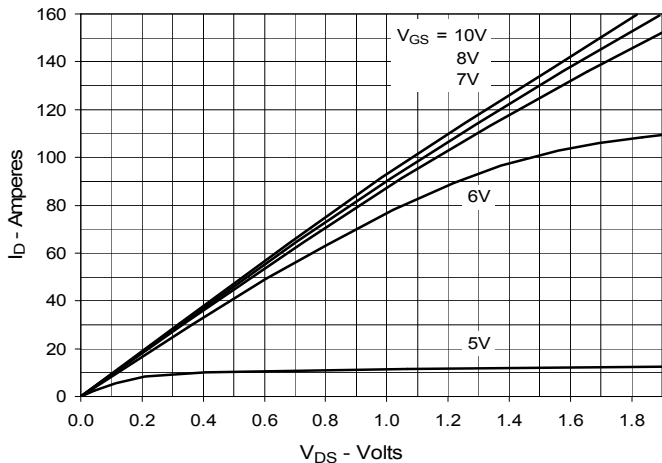

Fig. 2. Extended Output Characteristics @ 25°C

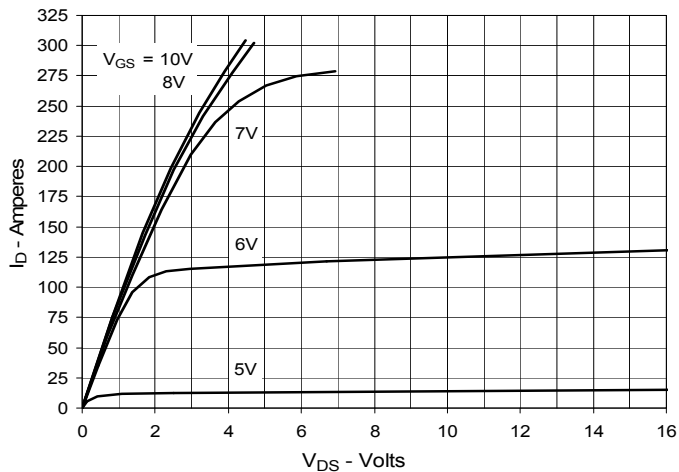

Fig. 3. Output Characteristics @ 150°C

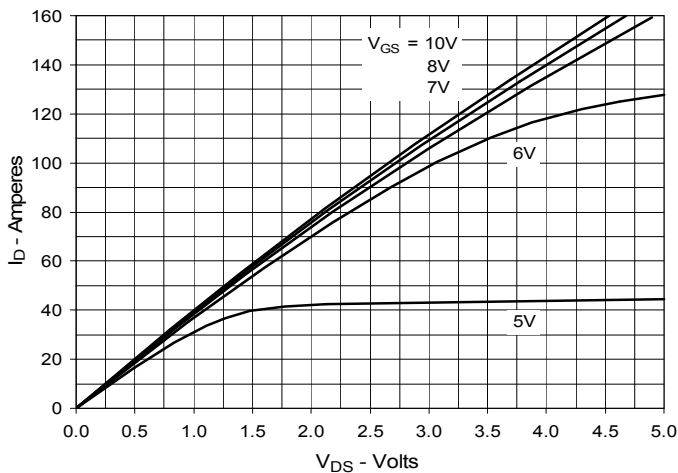

Fig. 4. $R_{DS(on)}$ Normalized to $I_D = 75A$ Value vs. Junction Temperature

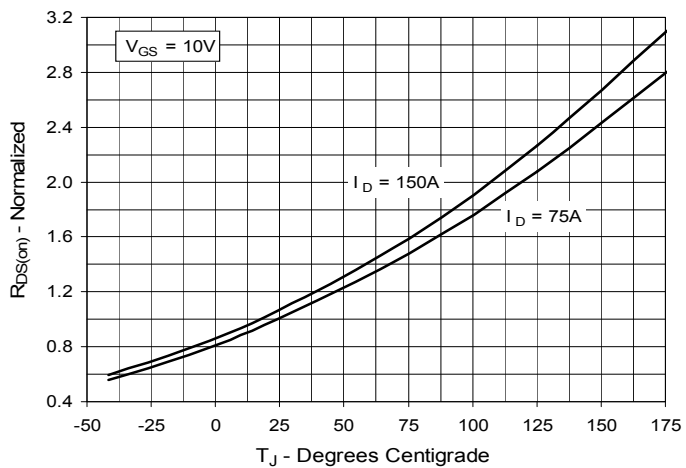

Fig. 5. $R_{DS(on)}$ Normalized to $I_D = 75A$ Value vs. Drain Current

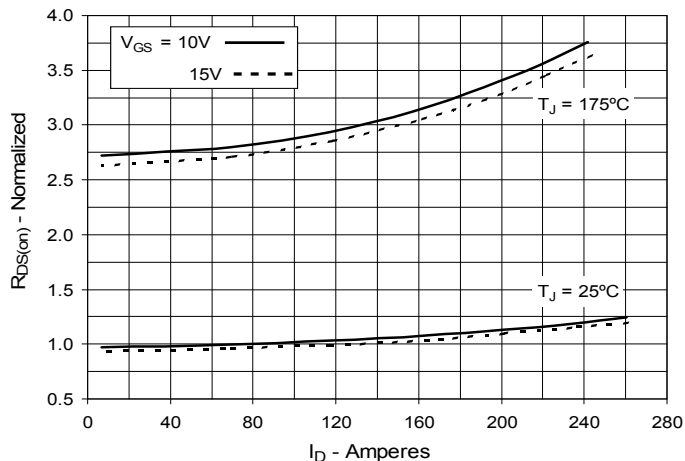

Fig. 6. Drain Current vs. Case Temperature

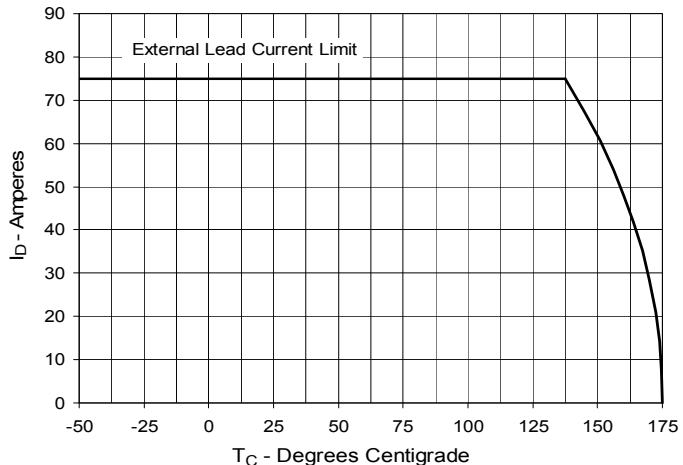

Fig. 7. Input Admittance

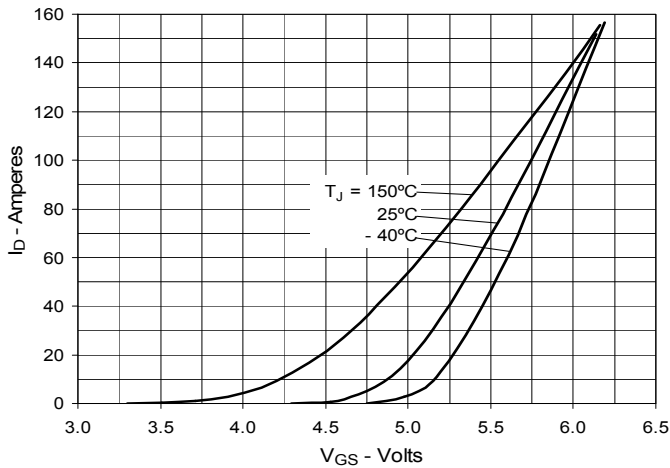

Fig. 8. Transconductance

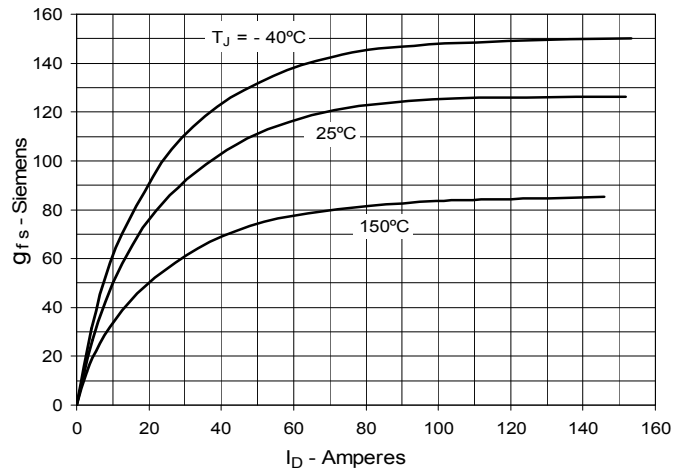

Fig. 9. Forward Voltage Drop of Intrinsic Diode

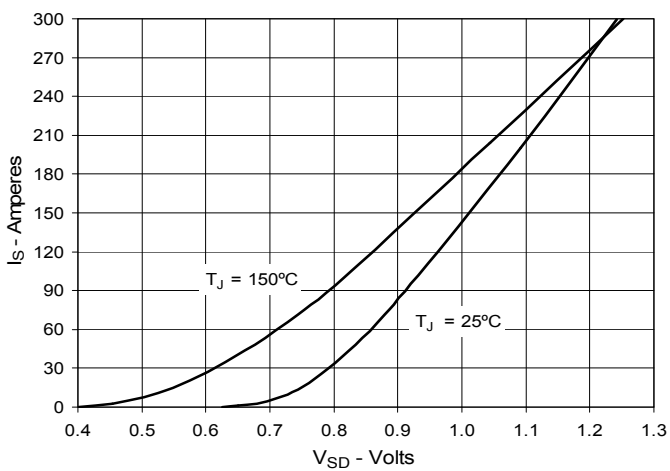

Fig. 10. Gate Charge

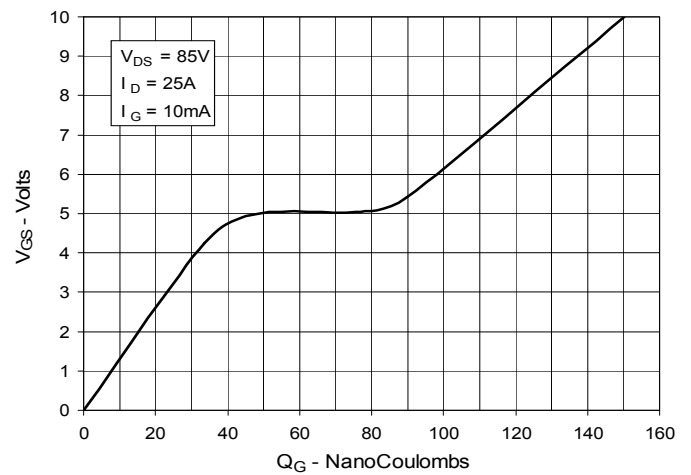

Fig. 11. Capacitance

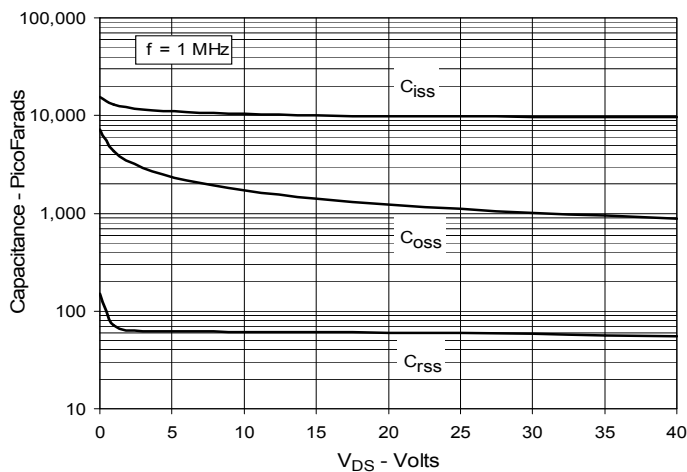
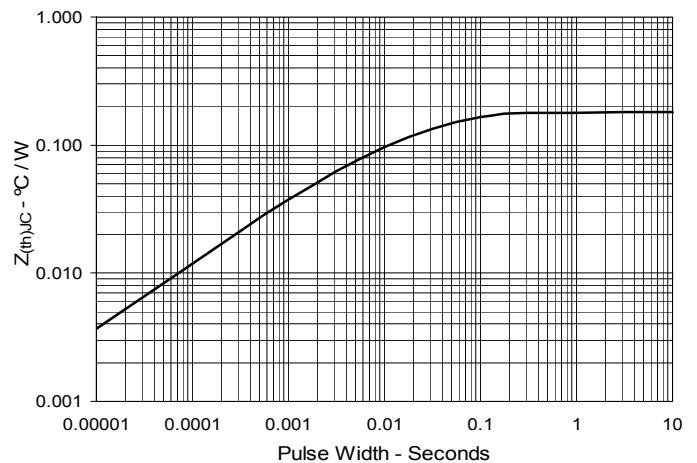

Fig. 12. Maximum Transient Thermal Impedance



IXYS reserves the right to change limits, test conditions, and dimensions.

Fig. 13. Resistive Turn-on Rise Time vs. Junction Temperature

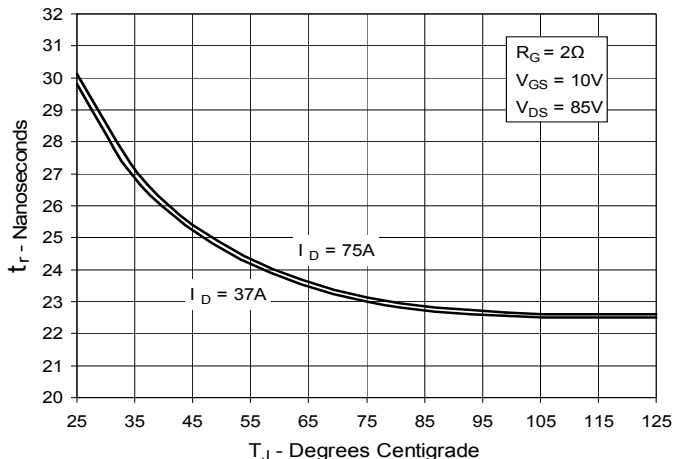

Fig. 14. Resistive Turn-on Rise Time vs. Drain Current

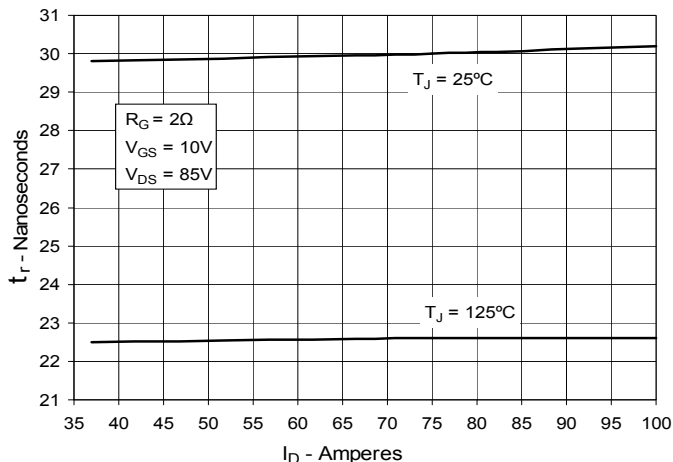

Fig. 15. Resistive Turn-on Switching Times vs. Gate Resistance

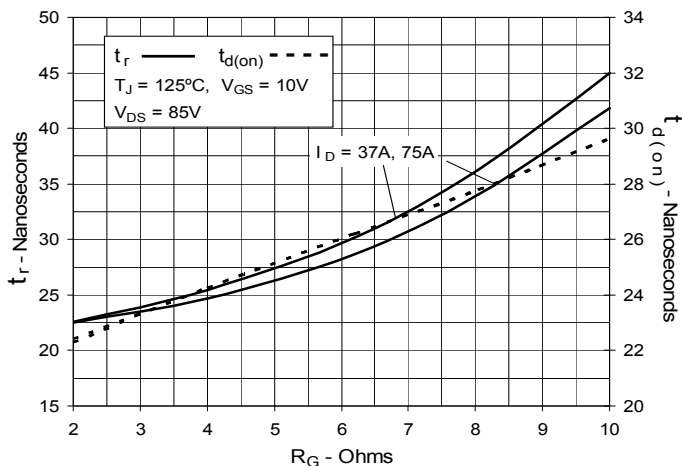

Fig. 16. Resistive Turn-off Switching Times vs. Junction Temperature

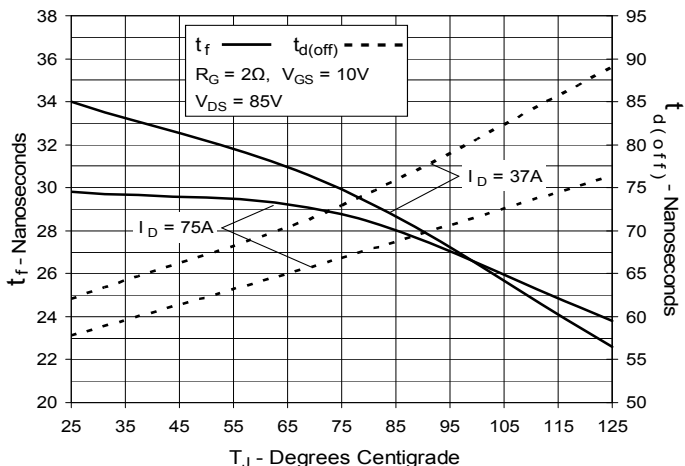

Fig. 17. Resistive Turn-off Switching Times vs. Drain Current

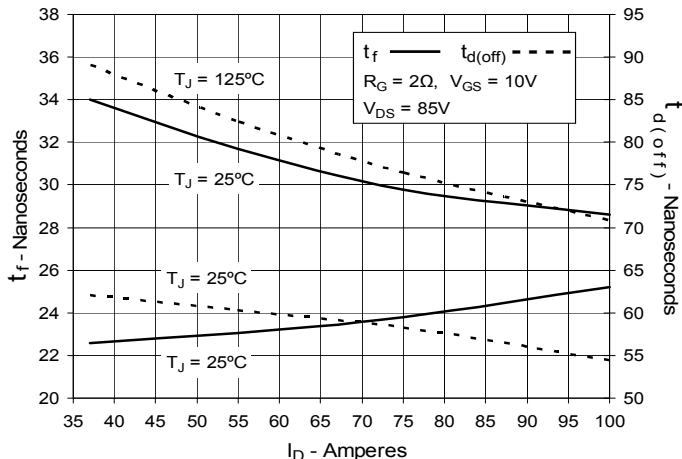

Fig. 18. Resistive Turn-off Switching Times vs. Gate Resistance

