

RSH Series

DC Ammeter Shunts / Busbar Shunts
15 Amp - 600 Amp

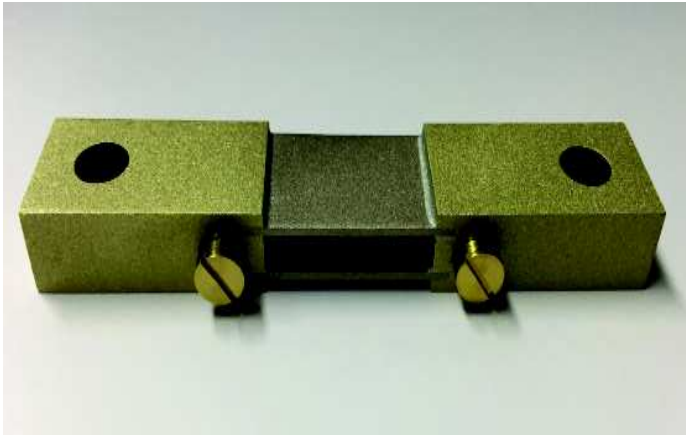
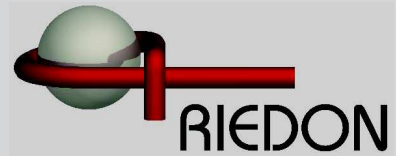

- 15 Amp to 600 Amp
- 0.25% Tolerance
- 0.083 mOhm to 3.33 mOhm
- Calibration Certificate Available

SPECIFICATIONS	
Rated Output	50mV, 100mV, Custom
Voltage Tolerance	±0.25% Standard
Operating Temp.	+30°C to +70°C
Storage Temp.	-55°C to 80°C
Materials	Resistance Element: Manganin Terminal Block RSH: Copper

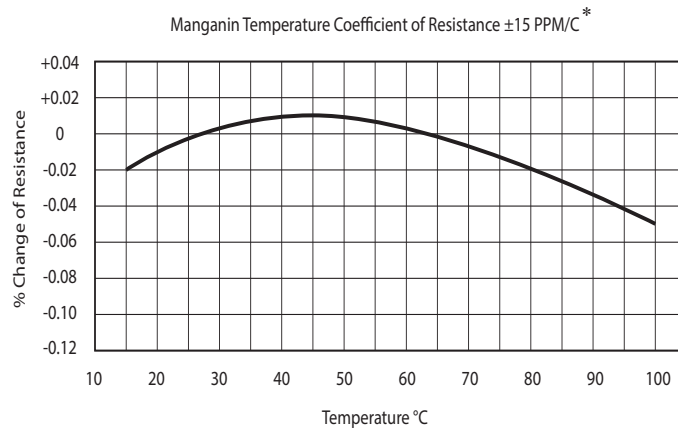

*Applies to resistance element only

Operating Current Derating: For continuous operation, it is recommended that shunts are not run at more than two thirds (2/3) the rated current under normal conditions per IEEE standards for DC instrument shunts. At ambient temperatures above 40°C, the current must be further derated to prevent damage.

Ordering Information

Part Description: Part Type - Voltage Output (mV)

Example: RSH - 15 - 50

RSH Series

DC Ammeter Shunts / Busbar Shunts
15 Amp - 600 Amp

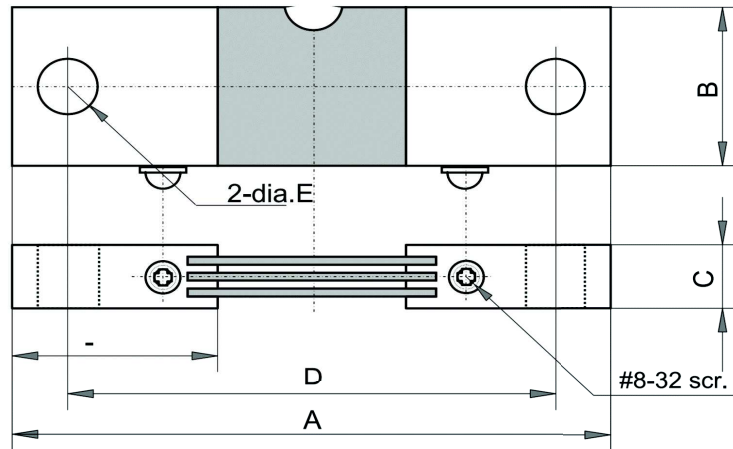
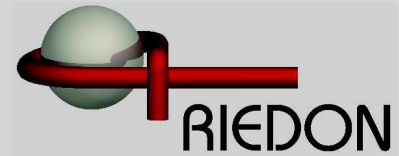

*Dimension tolerances: ± 0.381 mm for hole diameters. All other dimensions have a ± 0.762 mm tolerance

50mV Output								
Rated Current - Out (mV)	Rated Current (A)	Operating Current (A)	Resistance (m Ω)	Dimensions (mm)*				
				A	B	C	D	E
RSH-15-50	15	10	3.333	104.78	15.88	9.53	84.14	8.73
RSH-20-50	20	13.4	2.500	104.78	15.88	9.53	84.14	8.73
RSH-50-50	50	33.4	1.000	104.78	15.88	9.53	84.14	8.73
RSH-75-50	75	50	0.667	104.78	15.88	9.53	84.14	8.73
RSH-100-50	100	66.7	0.500	104.78	15.88	9.53	84.14	8.73
RSH-125-50	125	83.4	0.400	104.78	20.64	9.53	84.14	8.73
RSH-150-50	150	100	0.333	104.78	23.81	9.53	84.14	8.73
RSH-175-50	175	116.7	0.286	104.78	19.05	12.7	84.14	8.73
RSH-200-50	200	133.4	0.250	104.78	20.64	12.7	84.14	8.73
RSH-250-50	250	166.7	0.200	104.78	26.99	12.7	84.14	8.73
RSH-300-50	300	200	0.167	104.78	31.75	12.7	84.14	8.73
RSH-375-50	375	250	0.133	117.48	23.81	19.05	92.08	8.73
RSH-400-50	400	266.7	0.125	117.48	25.4	19.05	92.08	10.32
RSH-500-50	500	333.4	0.100	117.48	31.75	19.05	92.08	10.32
RSH-600-50	600	400	0.083	117.48	38.1	19.05	92.08	10.32
100mV Output								
Rated Current - Out (mV)	Rated Current (A)	Operating Current (A)	Resistance (m Ω)	Dimensions (mm)*				
				A	B	C	D	E
RSH-50-100	50	33.4	2.00	114.3	12.7	9.53	88.9	8.73
RSH-75-100	75	50	1.333	114.3	19.05	9.53	88.9	8.73
RSH-100-100	100	66.7	1.00	114.3	25.4	9.53	88.9	8.73
RSH-150-100	150	100	0.667	114.3	25.4	12.7	88.9	8.73
RSH-200-100	200	133.4	0.500	114.3	25.4	12.7	88.9	10.32
RSH-250-100	250	166.7	0.400	114.3	25.4	12.7	88.9	10.32
RSH-300-100	300	200	0.333	114.3	31.75	12.7	88.9	10.32
RSH-375-100	375	250	0.267	114.3	31.75	19.05	88.9	10.32
RSH-400-100	400	266.7	0.250	114.3	31.75	19.05	88.9	10.32
RSH-500-100	500	333.4	0.200	114.3	31.75	19.05	88.9	10.32
RSH-600-100	600	400	0.167	114.3	31.75	19.05	88.9	10.32

RSH Series

DC Ammeter Shunts / Busbar Shunts
15 Amp - 600 Amp

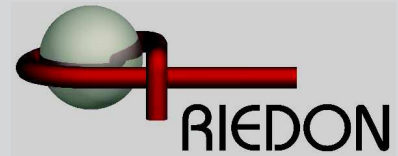

TECHNICAL NOTES

Mounting: Shunts should be mounted with manganin resistive blades in a vertical position in order to promote the free convectational flow of air. If vertical mounting is not practical, forced air cooling or adding heat sinks to the blocks can reduce the operating temperature. The manganin blades must never exceed +145°C, otherwise permanent resistance change may occur.

When current of 100A or greater is passing through the shunt, the major portion of heat generated is dissipated by conduction through the shunt terminal blocks into the connecting buss bar or cable. Therefore it is necessary to insure that good contact is made between the shunt terminal blocks and the conductor terminals and that the conductors have adequate cross section to keep the temperature of the shunt from exceeding 145°C (125°C recommended).

If the shunt is mounted in an enclosure, care must be taken to ensure adequate cooling. If the power density is greater than 1/4 watt per square inch of the enclosure surface for all enclosed devices, additional cooling must be supplied in the form of air vents or fans.

Shunts also must be installed in a way that protects them from thermal expansion forces produced from buss bar or short-circuit forces. Flexible wiring may be required in high pulse current, high vibration, or high temperature applications.

Where possible, all shunts should be mounted on the ground side of the circuit. For circuits above 750VDC, RS shunts **must** be mounted on the ground side due to the dielectric strength of the shunt base.

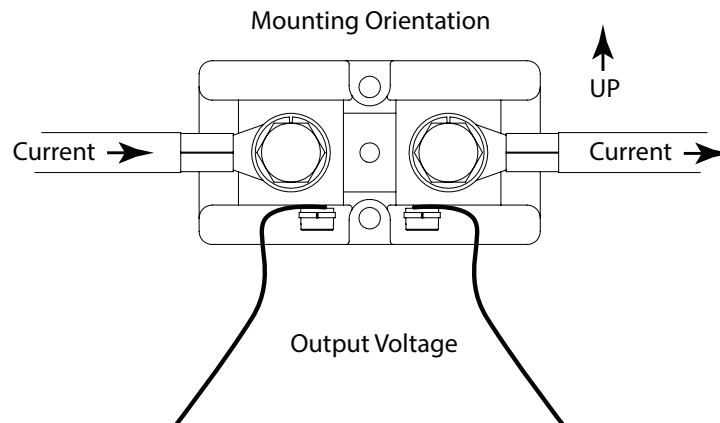

Operating Current Derating: For continuous operation, it is recommended that shunts are not run at more than two thirds (2/3) the rated current under normal conditions per IEEE standards for DC instrument shunts. At ambient temperatures above 40°C, the current must be further derated to prevent damage.

Pulse Operation: Shunts that do not need continuous operation and are only exposed to intermittent pulses can be operated at levels above their rated current for short periods of times. Pulses are limited to the maximum temperature of the blades not exceeding 145°C (125°C recommended). Many variables such as ambient temperature, cross section of the current carrying conductors, and pulse duration make calculating exact values difficult. Shunt size will need to be validated by customer for pulse current and duty cycle on a case by case basis.