

# IB IL 24 PWR IN/M

## Inline Power Terminal Without Fuse According to the Requirements of Germanischer Lloyd (GL)

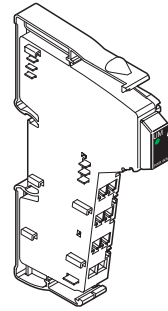

Data Sheet 6840A

08/2002

6840A001



This data sheet is only valid in association with the "Configuring and Installing the INTERBUS Inline Product Range" User Manual IB IL SYS PRO UM E.

## Function

The terminal is designed for use within an Inline station.

The terminal supplies 24 V supply voltage to the main circuit ( $U_M$ ) and thus provides the supply voltage to the segment circuit ( $U_S$ ).

The terminal has protective elements against conducted surge voltages, which are specifically designed to meet the requirements of Germanischer Lloyd.

The terminal provides the option of tapping the protected 24 V voltage ( $U_M/U_S$ ) to supply the bus terminal supply  $U_{BT}$  to a bus terminal (see Figure 6 on page 7).

## Features



This terminal does not have a protocol chip and is therefore not an INTERBUS device.

- Supply of the 24 V main voltage  $U_M$
- Provision of the 24 V segment voltage  $U_S$
- Provides protection for the station against conducted surge voltages
- Main and segment circuit protected by an external fuse
- Segment circuit can also be protected by a segment terminal
- Option to tap the protected 24 V voltage to provide the bus terminal supply  $U_{BT}$
- LED diagnostic indicator

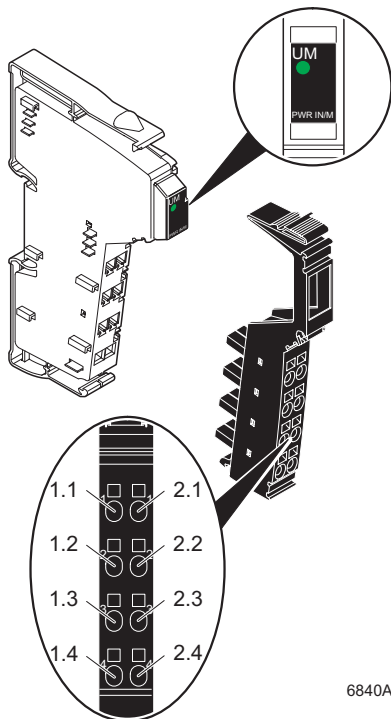

6840A002

Figure 1 IB IL 24 PWR IN/M with appropriate connector



Please note that the connector is not supplied as standard with the terminal. Please refer to the Ordering Data on page 11 to order the appropriate connector for your application.

### Terminal Assignment

Terminal Point	Assignment
1.1, 2.1, 1.2, 2.2	Supply points for the main circuit $U_M$ (+24 V) and the segment circuit $U_S$ (+24 V)  Protected 24 V voltage tapped to provide the bus terminal supply $U_{BT}$  These terminal points are connected with each other and with the potential jumper of the unprotected main supply $U_M$ and the segment supply $U_S$ . The potential jumpers of the unprotected main circuit $U_M$ and the segment circuit $U_S$ have a total current carrying capacity of 8 A.
1.3, 2.3	Ground contact (GND)  The reference potential is directly routed to the potential jumper and is, at the same time, ground reference for the main and segment voltage and for the bus terminal supply $U_{BT}$ .
1.4, 2.4	FE connection  The contacts are directly connected with the potential jumper and the FE spring on the bottom of the housing. The terminal is grounded when it is snapped onto a grounded DIN rail.
	Terminal points 1.1, 1.2, and 1.3 are connected with a capacitor to FE.

### Function Identification

Black

### Local LED Diagnostic Indicator

Des.	Color	Meaning
UM	Green	24 V voltage present (in the main circuit $U_M$ and in the segment circuit $U_S$ )



### Observe the current carrying capacity

The maximum total current flowing through the potential jumpers must not exceed 8 A.

## Internal Circuit Diagram

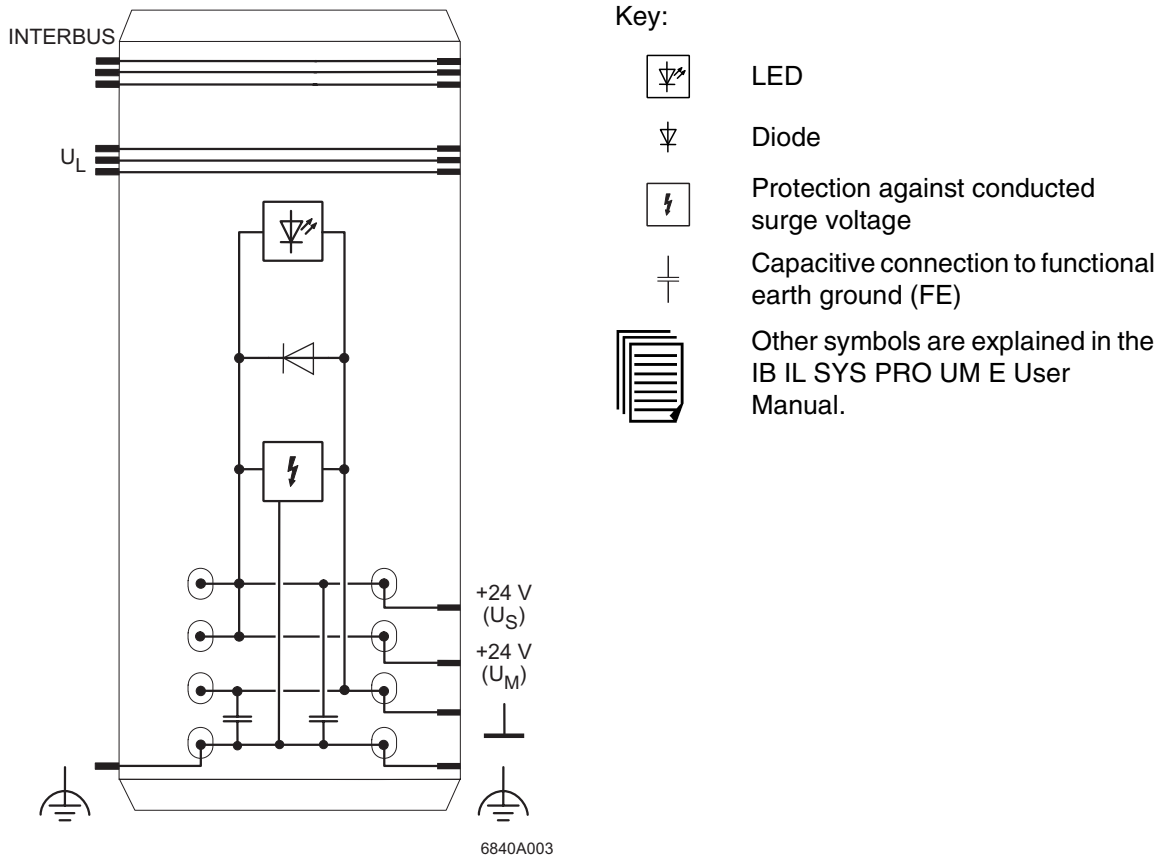

Figure 2 Internal wiring of the terminal points

## Connection Example



Protect the 24 V supply with an external fuse.

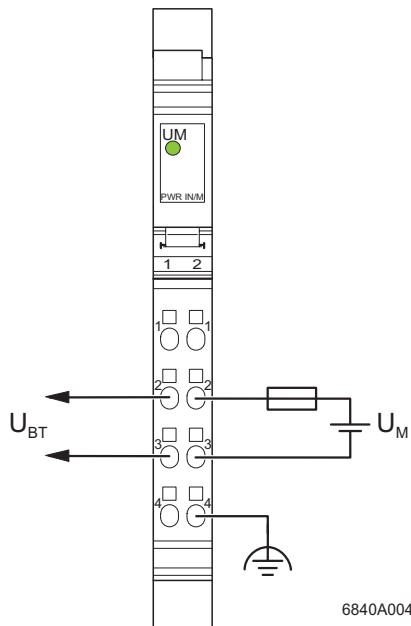

Figure 3 Typical connection of the supply voltage  $U_M$  and tapping of the bus terminal supply  $U_{BT}$



The segment voltage  $U_S$  is provided automatically.



To ensure maximum current carrying capacity, use a power connector to connect the cables (see page 11). In these connectors, the adjacent terminal points 1.2 and 2.2, and 1.3 and 2.3 are jumpered internally.

## Important Notes

Only Inline terminals, which are approved by GL, can be used within an Inline station that meets the requirements of GL (see page 6).

The IB IL 24 PWR IN/M power terminal is used to protect the Inline station against conducted surge voltages according the requirements of Germanischer Lloyd (GL approval).

Only lead the supply cables to your Inline station via IB IL 24 PWR IN/M power terminals to ensure optimum protection of the Inline station against conducted surge voltages (see Figure 6 on page 7).

Ground each IB IL 24 PWR IN/M power terminal in the Inline station using the FE terminal point (1.4 or 2.4). Contrary to information given in the IB IL SYS PRO UM E User Manual, the station is **only grounded using all** power terminals and **not** using the bus terminal (see Figure 4).

Please note that the electrical isolation between functional earth ground and the I/O is 175 V AC when using the IB IL 24 PWR IN/M terminal within an Inline station.

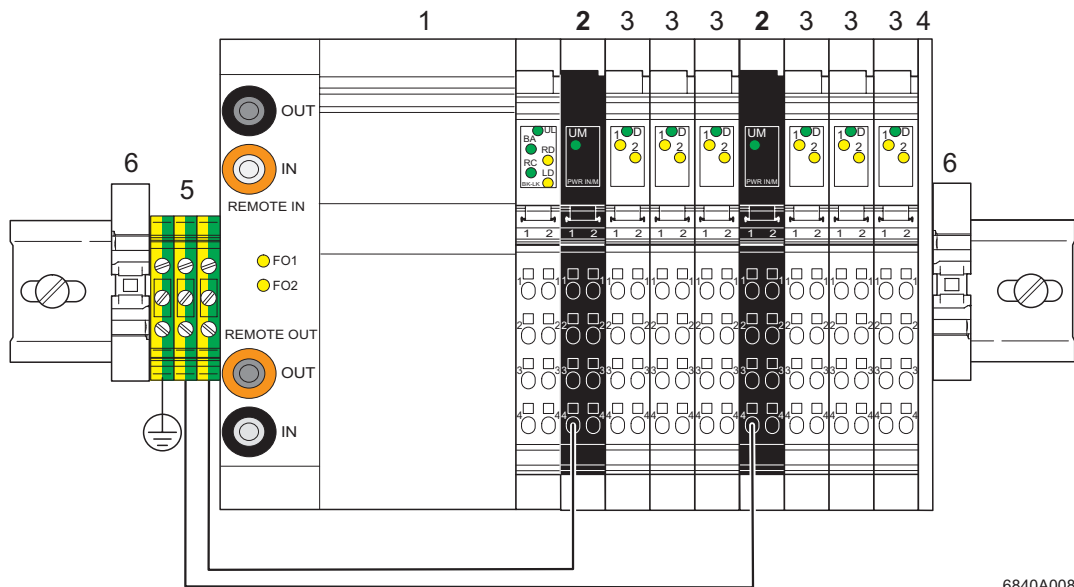

684A008

Figure 4 Grounding an Inline station according to GL approval

Key:

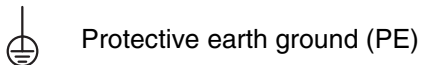

No.	Function	Example
1	Bus terminal	IBS IL 24 BK-LK
2	Power terminal	IB IL 24 PWR IN/M
3	Terminals with GL approval according to the application	See "GL Approved Inline Terminals" on page 6 for approved terminals
4	End plate as end of the Inline station	Supplied with the bus terminal
5	Grounding terminal blocks (Universal ground terminal block)	USLKG ... according to the configuration (see CLIPLINE catalog from Phoenix Contact).
6	End clamp	CLIPFIX 35

## GL Approved Inline Terminals

Only Inline terminals, which are approved by GL, can be used within an Inline station that meets the requirements of GL.

Order No.	Order Designation	Hardware Revision (or Later)	Firmware Revision (or Later)
27 26 19 1	IBS IL 24 BK-LK	04	002
27 26 20 1	IB IL 24 DI 2	05	–
28 61 22 1	IB IL 24 DI 2-PAC	05	–
27 26 25 6	IB IL 24 DO 4	05	–
28 61 27 6	IB IL 24 DO 4-PAC	05	–
27 27 74 7	IB IL 24 SEG/F	03	–
28 61 37 3	IB IL 24 SEG/F-PAC	03	–



This list is continuously being extended. More information on new approved terminals can be found on the Internet.



The hardware revision is imprinted on the side of the housing of every terminal. For terminals with firmware, the firmware revision is also imprinted on the side of the terminal housing.

The GL mark is imprinted on terminals that have been approved according to the requirements of Germanischer Lloyd.

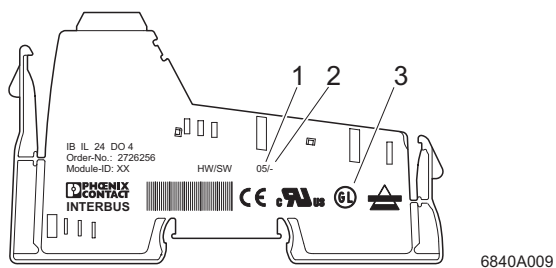

Key:

- 1 Hardware revision
- 2 Firmware revision
- 3 GL mark

Figure 5 Imprinting on an Inline terminal

## Installation Examples

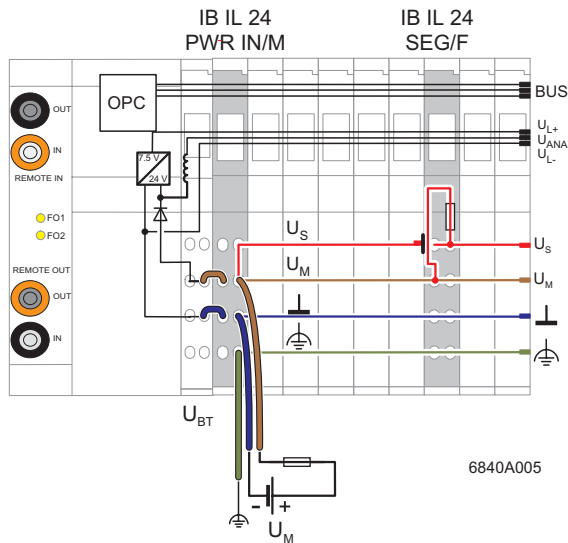

Figure 6 IB IL 24 PWR IN/M after a bus terminal

The main voltage  $U_M$  is supplied to the IB IL 24 PWR IN/M terminal in the Inline station. The segment voltage  $U_S$  is provided automatically. The bus terminal supply  $U_{BT}$  is tapped from the protected 24 V voltage.

Another segment is opened using a segment terminal (given here as an example; a segment terminal with fuse).

In this example, there is no electrical isolation between the logic ( $U_L$  generated from  $U_{BT}$ ) and I/O ( $U_M/U_S$ ).

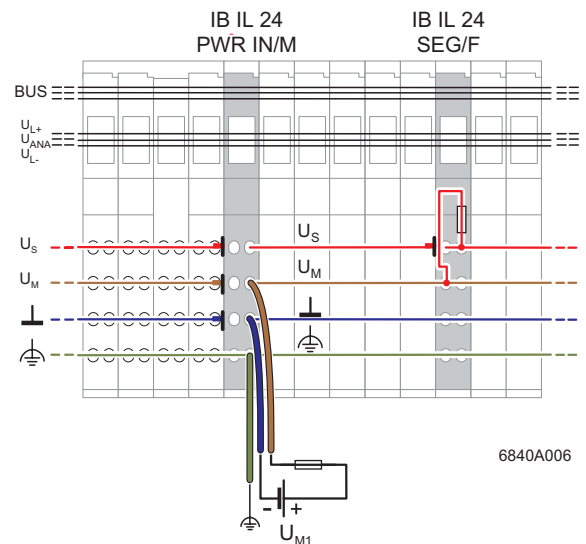



Figure 7 IB IL 24 PWR IN/M to create a new main circuit

The main voltage  $U_M$  is reintroduced to the IB IL 24 PWR IN/M terminal. This opens an electrically isolated main circuit within the Inline station. The segment voltage  $U_S$  is provided automatically.

Another segment is opened using a segment terminal (given here as an example; a segment terminal with fuse).

In this example, there is electrical isolation between the logic ( $U_L$  generated from  $U_{BT}$ ) and I/O ( $U_M/U_S$ ).

## Technical Data

General Data	
Order Designation	IB IL 24 PWR IN/M
Order No.	28 61 02 7
Housing dimensions (width x height x depth)	12.2 mm x 120 mm x 71.5 mm (0.480 x 4.724 x 2.815 in.)
Weight	50 g (without connectors)
Permissible temperature (operation)	-25°C to +55°C (-13°F to +131°F)
Permissible temperature (storage/transport)	-25°C to +85°C (-13°F to +185°F)
Permissible humidity (operation)	75% on average, 85% occasionally
	In the range from -25°C to +55°C (-13°F to +131°F) appropriate measures against increased humidity (> 85%) must be taken.
Permissible humidity (storage/transport)	75% on average, 85% occasionally
	For a short period, slight condensation may appear on the outside of the housing if, for example, the terminal is brought into a closed room from a vehicle.
Permissible air pressure (operation)	80 kPa to 106 kPa (up to 2000 m [6562 ft.] above sea level)
Permissible air pressure (storage/transport)	70 kPa to 106 kPa (up to 3000 m [9843 ft.] above sea level)
Degree of protection	IP 20 according to IEC 60529
Class of protection	Class 3 according to VDE 0106, IEC 60536
24 V I/O Supply (Main Circuit U <sub>M</sub> )	
Connection	+24 V Ground (GND) Terminal points 1.1, 2.1, 1.2, and 2.2 Terminal points 1.3 and 2.3
Rated value	24 V DC
Tolerance	-15%/+20%
AC component	5%



24 V I/O Supply (Main Circuit $U_M$ ) (Continued)	
Permissible range	19.2 V to 30 V
Permissible current	8 A, maximum
Demands on the voltage supply	<p>The power terminal must be supplied from a new power supply unit to provide electrical isolation. Protect the 24 V power supply with an external fuse.</p> <div style="display: flex; align-items: center;">  <div style="border: 1px solid black; background-color: yellow; padding: 5px;"> <p>The power supply unit must be able to supply 4 times (400%) the nominal current of the external fuse.</p> </div> </div>

Safety Measures	
Overload/short circuit in segment circuit	No
Surge voltage	<p>Yes;</p> <p>suppressor diode for voltage limitation between terminal points 1.2 and 1.3</p> <p>varistors for voltage limitation between terminal points 1.2 and 1.4 and terminal points 1.3 and 1.4</p>
Polarity reversal	<p>Yes; diode connected in parallel as protection against polarity reversal</p> <div style="display: flex; align-items: center;">  <div style="border: 1px solid black; background-color: yellow; padding: 5px;"> <p>The power supply unit must be able to supply 4 times (400%) the nominal current of the external fuse.</p> </div> </div>

**Electrical Isolation/Isolation of the Voltage Areas**



To provide electrical isolation between the logic level and the I/O area, it is necessary to supply these areas via two power terminals from separate power supply units. Inter-connection of the 24 V power supplies is not permitted. Please pay attention to GND/PE connections on the power supply units (see also user manual).

**Common Potentials**

The 24 V main voltage supply, 24 V segment voltage, and GND have the same potential. FE is a separate potential area.

**Separate Potentials in the System Consisting of Bus Terminal/Power Terminal and I/O Terminal**

- Test Distance	- Test Voltage
5 V supply incoming remote bus/7.5 V supply (bus logic)	500 V AC, 50 Hz, 1 min.
5 V supply outgoing remote bus/7.5 V supply (bus logic)	500 V AC, 50 Hz, 1 min.
7.5 V supply (bus logic)/24 V supply (I/O)*	500 V AC, 50 Hz, 1 min.
24 V supply (I/O)/functional earth ground	175 V AC, 50 Hz, 1 min.**

\* Only applies if the communications power (supplied in the bus terminal from  $U_{BT}$ ) and I/O voltage ( $U_M$ ,  $U_S$ ) are supplied separately.

\*\* Test voltage reduced due to voltage limiting elements.

**Approvals**

CE	Yes
UL/CUL	Applied for
GL Category A, B, C, D, EMC2	Applied for

**Error Messages to the Higher-Level Control or Computer System**

None	
------	--

## Ordering Data

Description	Order Designation	Order No.
Power terminal without fuse according to the requirements of Germanischer Lloyd (GL)	IB IL 24 PWR IN/M	28 61 02 7
 <div style="background-color: yellow; padding: 5px; border: 1px solid black;"> <p>You need one connector for the power supply of the terminal.</p> </div>		
Connector for power supply (black, w/o color print) pack of 10	IB IL SCN-PWR IN	27 27 46 2
Connector for power supply (black, with color print) pack of 10	IB IL SCN-PWR IN-CP	27 27 63 7
"Configuring and Installing the INTERBUS Inline Product Range" User Manual	IB IL SYS PRO UM E	27 43 04 8



Documentation is available to download free of charge at [www.phoenixcontact.com](http://www.phoenixcontact.com).

Phoenix Contact GmbH & Co. KG  
Flachsmarktstr. 8  
32825 Blomberg  
Germany



+49 - 52 35 - 30 0



+49 - 52 35 - 34 12 00



[www.phoenixcontact.com](http://www.phoenixcontact.com)



Worldwide Locations:

[www.phoenixcontact.com/salesnetwork](http://www.phoenixcontact.com/salesnetwork)