



MICROCHIP

**MTD6501D
12V 3-Phase BLDC
Sensorless Fan Controller
Daughter Board User's Guide
(ADM00533)**

Note the following details of the code protection feature on Microchip devices:

- Microchip products meet the specification contained in their particular Microchip Data Sheet.
- Microchip believes that its family of products is one of the most secure families of its kind on the market today, when used in the intended manner and under normal conditions.
- There are dishonest and possibly illegal methods used to breach the code protection feature. All of these methods, to our knowledge, require using the Microchip products in a manner outside the operating specifications contained in Microchip's Data Sheets. Most likely, the person doing so is engaged in theft of intellectual property.
- Microchip is willing to work with the customer who is concerned about the integrity of their code.
- Neither Microchip nor any other semiconductor manufacturer can guarantee the security of their code. Code protection does not mean that we are guaranteeing the product as "unbreakable."

Code protection is constantly evolving. We at Microchip are committed to continuously improving the code protection features of our products. Attempts to break Microchip's code protection feature may be a violation of the Digital Millennium Copyright Act. If such acts allow unauthorized access to your software or other copyrighted work, you may have a right to sue for relief under that Act.

Information contained in this publication regarding device applications and the like is provided only for your convenience and may be superseded by updates. It is your responsibility to ensure that your application meets with your specifications. MICROCHIP MAKES NO REPRESENTATIONS OR WARRANTIES OF ANY KIND WHETHER EXPRESS OR IMPLIED, WRITTEN OR ORAL, STATUTORY OR OTHERWISE, RELATED TO THE INFORMATION, INCLUDING BUT NOT LIMITED TO ITS CONDITION, QUALITY, PERFORMANCE, MERCHANTABILITY OR FITNESS FOR PURPOSE. Microchip disclaims all liability arising from this information and its use. Use of Microchip devices in life support and/or safety applications is entirely at the buyer's risk, and the buyer agrees to defend, indemnify and hold harmless Microchip from any and all damages, claims, suits, or expenses resulting from such use. No licenses are conveyed, implicitly or otherwise, under any Microchip intellectual property rights unless otherwise stated.

Microchip received ISO/TS-16949:2009 certification for its worldwide headquarters, design and wafer fabrication facilities in Chandler and Tempe, Arizona; Gresham, Oregon and design centers in California and India. The Company's quality system processes and procedures are for its PIC® MCUs and dsPIC® DSCs, KEELOQ® code hopping devices, Serial EEPROMs, microperipherals, nonvolatile memory and analog products. In addition, Microchip's quality system for the design and manufacture of development systems is ISO 9001:2000 certified.

**QUALITY MANAGEMENT SYSTEM
CERTIFIED BY DNV
= ISO/TS 16949 =**

Trademarks

The Microchip name and logo, the Microchip logo, AnyRate, dsPIC, FlashFlex, flexPWR, Heldo, JukeBlox, KeeLoq, KeeLoq logo, Klear, LANCheck, LINK MD, MediaLB, MOST, MOST logo, MPLAB, OptoLyzer, PIC, PICSTART, PIC32 logo, RightTouch, SpyNIC, SST, SST Logo, SuperFlash and UNI/O are registered trademarks of Microchip Technology Incorporated in the U.S.A. and other countries.

ClockWorks, The Embedded Control Solutions Company, ETHERSYNCH, Hyper Speed Control, HyperLight Load, IntelliMOS, mTouch, Precision Edge, and QUIET-WIRE are registered trademarks of Microchip Technology Incorporated in the U.S.A.

Analog-for-the-Digital Age, Any Capacitor, AnyIn, AnyOut, BodyCom, chipKIT, chipKIT logo, CodeGuard, dsPICDEM, dsPICDEM.net, Dynamic Average Matching, DAM, ECAN, EtherGREEN, In-Circuit Serial Programming, ICSP, Inter-Chip Connectivity, JitterBlocker, KlearNet, KlearNet logo, MiWi, motorBench, MPASM, MPF, MPLAB Certified logo, MPLIB, MPLINK, MultiTRAK, NetDetach, Omniscient Code Generation, PICDEM, PICDEM.net, PICkit, PICtail, PureSilicon, RightTouch logo, REAL ICE, Ripple Blocker, Serial Quad I/O, SQL, SuperSwitcher, SuperSwitcher II, Total Endurance, TSHARC, USBCheck, VariSense, ViewSpan, WiperLock, Wireless DNA, and ZENA are trademarks of Microchip Technology Incorporated in the U.S.A. and other countries.

SQTP is a service mark of Microchip Technology Incorporated in the U.S.A.

Silicon Storage Technology is a registered trademark of Microchip Technology Inc. in other countries.

GestIC is a registered trademarks of Microchip Technology Germany II GmbH & Co. KG, a subsidiary of Microchip Technology Inc., in other countries.

All other trademarks mentioned herein are property of their respective companies.

© 2016, Microchip Technology Incorporated, Printed in the U.S.A., All Rights Reserved.

ISBN: 978-1-5224-0594-8



MTD6501D 12V 3-PHASE BLDC SENSORLESS FAN CONTROLLER DAUGHTER BOARD USER'S GUIDE

Table of Contents

Preface	7
Introduction.....	7
Document Layout	7
Conventions Used in this Guide	8
Recommended Reading.....	9
The Microchip Website.....	9
Customer Support	9
Document Revision History	9
Chapter 1. Product Overview	
1.1 Introduction	11
1.2 MTD6501D Daughter Board Features	12
1.3 What the MTD6501D 12V 3-Phase BLDC Sensorless Fan Controller Daughter Board Kit Includes	13
Chapter 2. Installation and Operation	
2.1 Getting Started	15
Appendix A. Schematics and Layouts	
A.1 Introduction	17
A.2 MTD6501D Daughter Board – Schematic	18
A.3 MTD6501D Daughter Board – Top Silk	18
A.4 MTD6501D Daughter Board – Top Copper and Silk	19
A.5 MTD6501D Daughter Board – Top Copper	19
A.6 MTD6501D Daughter Board – Bottom Copper	19
A.7 MTD6501D Daughter Board – Bottom Copper and Silk	20
A.8 MTD6501D Daughter board – Bottom Silk	20
Appendix B. Bill of Materials (BOM)	21
Worldwide Sales and Service	22

NOTES:

Object of Declaration: MTD6501D 12V 3-Phase BLDC Sensorless Fan Controller Daughter Board

EU Declaration of Conformity

Manufacturer: Microchip Technology Inc.
2355 W. Chandler Blvd.
Chandler, Arizona, 85224-6199
USA

This declaration of conformity is issued by the manufacturer.

The development/evaluation tool is designed to be used for research and development in a laboratory environment. This development/evaluation tool is not a Finished Appliance, nor is it intended for incorporation into Finished Appliances that are made commercially available as single functional units to end users under EU EMC Directive 2004/108/EC and as supported by the European Commission's Guide for the EMC Directive 2004/108/EC (8th February 2010).

This development/evaluation tool complies with EU RoHS2 Directive 2011/65/EU.

This development/evaluation tool, when incorporating wireless and radio-telecom functionality, is in compliance with the essential requirement and other relevant provisions of the R&TTE Directive 1999/5/EC and the FCC rules as stated in the declaration of conformity provided in the module datasheet and the module product page available at www.microchip.com.

For information regarding the exclusive, limited warranties applicable to Microchip products, please see Microchip's standard terms and conditions of sale, which are printed on our sales documentation and available at www.microchip.com.

Signed for and on behalf of Microchip Technology Inc. at Chandler, Arizona, USA

Derek Carlson
VP Development Tools

12-Sep-14
Date

NOTES:



MTD6501D 12V 3-PHASE BLDC SENSORLESS FAN CONTROLLER DAUGHTER BOARD USER'S GUIDE

Preface

NOTICE TO CUSTOMERS

All documentation becomes dated, and this manual is no exception. Microchip tools and documentation are constantly evolving to meet customer needs, so some actual dialogs and/or tool descriptions may differ from those in this document. Please refer to our website (www.microchip.com) to obtain the latest documentation available.

Documents are identified with a “DS” number. This number is located on the bottom of each page, in front of the page number. The numbering convention for the DS number is “DSXXXXXXXXA”, where “XXXXXXXX” is the document number and “A” is the revision level of the document.

For the most up-to-date information on development tools, see the MPLAB® IDE online help. Select the Help menu, and then Topics to open a list of available online help files.

INTRODUCTION

This chapter contains general information that will be useful to know before using the MTD6501D 12V 3-Phase BLDC Sensorless Fan Controller Daughter Board (ADM00533). Items discussed in this chapter include:

- Document Layout
- Conventions Used in this Guide
- Recommended Reading
- The Microchip Website
- Customer Support
- Document Revision History

DOCUMENT LAYOUT

This document describes how to use the MTD6501D 12V 3-Phase BLDC Sensorless Fan Controller Daughter Board as an evaluation tool to debug on a target motor system. The manual layout is as follows:

- **Chapter 1. “Product Overview”** – Important information about the MTD6501D 12V 3-Phase BLDC Sensorless Fan Controller Daughter Board.
- **Chapter 2. “Installation and Operation”** – Includes instructions on how to get started with the MTD6501D 12V 3-Phase BLDC Sensorless Fan Controller Daughter Board.
- **Appendix A. “Schematics and Layouts”** – Shows the schematic and layout diagrams for the MTD6501D 12V 3-Phase BLDC Sensorless Fan Controller Daughter Board.
- **Appendix B. “Bill of Materials (BOM)”** – Lists the parts used to build the MTD6501D 12V 3-Phase BLDC Sensorless Fan Controller Daughter Board.

CONVENTIONS USED IN THIS GUIDE

This manual uses the following documentation conventions:

DOCUMENTATION CONVENTIONS

Description	Represents	Examples
Arial font:		
Italic characters	Referenced books	<i>MPLAB[®] IDE User's Guide</i>
	Emphasized text	...is the <i>only</i> compiler...
Initial caps	A window	the Output window
	A dialog	the Settings dialog
	A menu selection	select Enable Programmer
Quotes	A field name in a window or dialog	"Save project before build"
Underlined, italic text with right angle bracket	A menu path	<u><i>File>Save</i></u>
Bold characters	A dialog button	Click OK
	A tab	Click the Power tab
N'Rnnnn	A number in verilog format, where N is the total number of digits, R is the radix and n is a digit.	4'b0010, 2'hF1
Text in angle brackets < >	A key on the keyboard	Press <Enter>, <F1>
Courier New font:		
Plain Courier New	Sample source code	#define START
	Filenames	autoexec.bat
	File paths	c:\mcc18\h
	Keywords	_asm, _endasm, static
	Command-line options	-Opa+, -Opa-
	Bit values	0, 1
	Constants	0xFF, 'A'
Italic Courier New	A variable argument	<i>file.o</i> , where <i>file</i> can be any valid filename
Square brackets []	Optional arguments	mcc18 [options] <i>file</i> [options]
Curly brackets and pipe character: { }	Choice of mutually exclusive arguments; an OR selection	errorlevel {0 1}
Ellipses...	Replaces repeated text	var_name [, var_name...]
	Represents code supplied by user	void main (void) { ... }

RECOMMENDED READING

This user's guide describes how to use the MTD6501D 12V 3-Phase BLDC Sensorless Fan Controller Daughter Board. Other useful documents are listed below. The following Microchip documents are available and recommended as supplemental reference resources:

- **MTD6501C/D/G Data Sheet** – “*3-Phase Brushless DC Sinusoidal Sensorless Fan Motor Driver*” (DS22263)
- **MCP8063 Data Sheet** – “*3-Phase Brushless Sinusoidal Sensorless Motor Driver*” (DS20005257)
- **MCP8063 User Guide** – “*12V 3-Phase BLDC Sensorless Fan Controller Demonstration Board Kit User’s Guide*” (DS50002248)

THE MICROCHIP WEBSITE

Microchip provides online support via our website at www.microchip.com. This website is used as a means to make files and information easily available to customers. Accessible by using your favorite Internet browser, the website contains the following information:

- **Product Support** – Data sheets and errata, application notes and sample programs, design resources, user’s guides and hardware support documents, latest software releases and archived software
- **General Technical Support** – Frequently Asked Questions (FAQs), technical support requests, online discussion groups, Microchip consultant program member listing
- **Business of Microchip** – Product selector and ordering guides, latest Microchip press releases, listing of seminars and events, listings of Microchip sales offices, distributors and factory representatives

CUSTOMER SUPPORT

Users of Microchip products can receive assistance through several channels:

- Distributor or Representative
- Local Sales Office
- Field Application Engineer (FAE)
- Technical Support

Customers should contact their distributor, representative or field application engineer (FAE) for support. Local sales offices are also available to help customers. A listing of sales offices and locations is included in the back of this document.

Technical support is available through the website at:
<http://www.microchip.com/support>.

DOCUMENT REVISION HISTORY

Revision A (September 2016)

- Initial release of this document.

NOTES:

Chapter 1. Product Overview

1.1 INTRODUCTION

In order to easily use the MTD6501D device, Microchip provides daughter boards for each MTD6501 device version: MTD6501D, MTD6501G and MTD6501C. This document covers the MTD6501D Daughter Board.

The MTD6501D Daughter Board is a small board with the minimum components that are necessary to operate with the MTD6501D device.

The MTD6501D Daughter Boards are designed to be used with the ADM00532 motherboard, but can also be operated as standalone boards using their connectors.

The MTD6501D Daughter Boards come with a kit of three boards.

Note: In order to operate with a 3-phase BLDC motor, ensure you have direct access to the three phases (also called U, V, W) of the motor. See [Figure 1-3](#).

The MTD6501D Daughter Board footprint and connections are represented in [Figure 1-1](#).

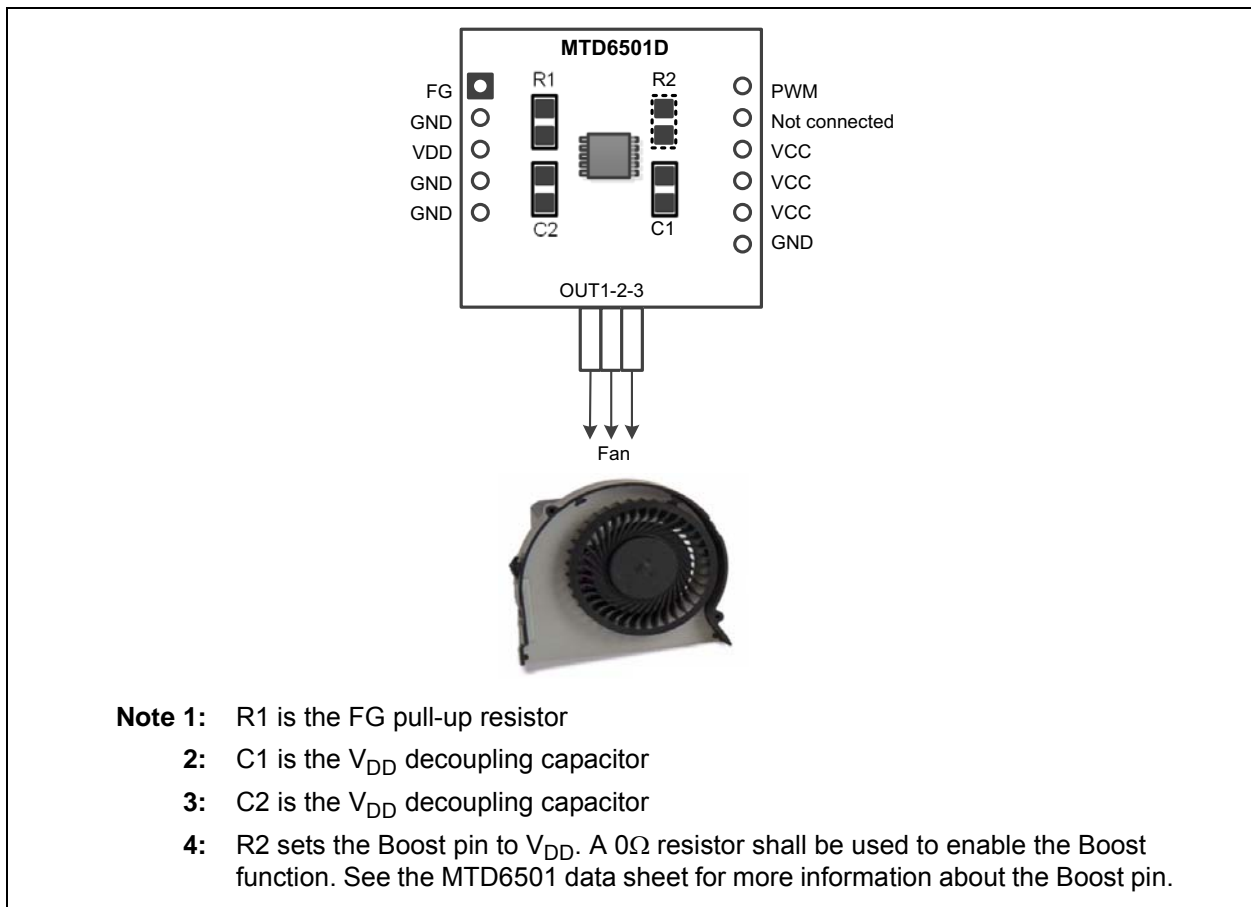

FIGURE 1-1: MTD6501D Daughter Board Footprint and Connections.

The board overview is represented in [Figure 1-2](#).

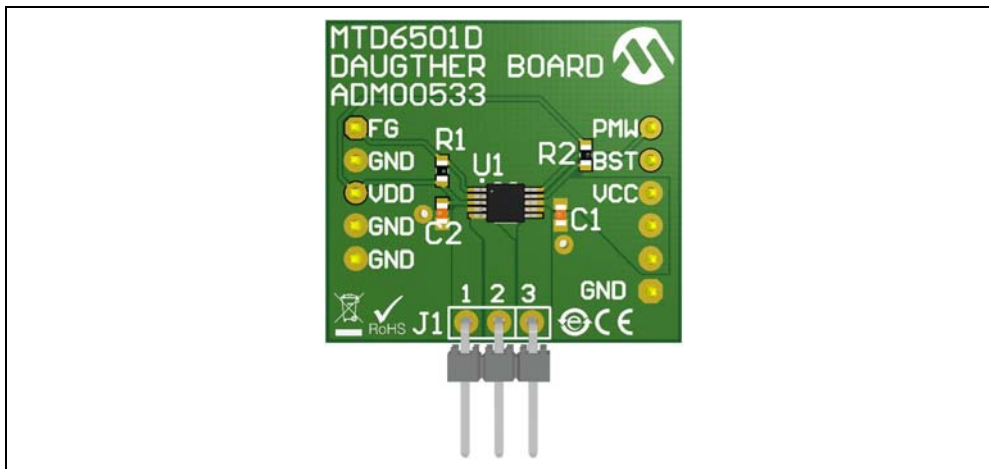

FIGURE 1-2: MTD6501D 12V 3-Phase BLDC Sensorless Fan Controller Daughter Board User's Guide Overview.

For more information, see [Appendix A. "Schematics and Layouts"](#).

1.2 MTD6501D DAUGHTER BOARD FEATURES

The MTD6501D Daughter Board can be used as standalone board (see [Section 2.1 "Getting Started"](#)) but it is strongly recommended to use the MTD6501D Daughter Board with the help of the MCP8063 12V 3-Phase BLDC Sensorless Fan Controller Demonstration Board (ADM00532).

The MTD6501D 12V 3-Phase BLDC Sensorless Fan Controller Daughter Board Kit allows the control and monitoring of Microchip 12V fan driver devices, such as the MCP8063 or MTD6501. The MTD6501D 12V 3-Phase BLDC Sensorless Fan Controller Daughter Board is controlled through PC software, via a USB connection.

The MTD6501D 12V 3-Phase BLDC Sensorless Fan Controller Daughter Board's software provides several features, such as:

- Fan driver power supply control and monitoring
- Pulse-width modulation (PWM) control
- Speed and current consumption monitoring
- Automatic application testing.

See more information about the MCP8063 kit on the Microchip website.

Figure 1-3 shows how the software, the board and the fan interact with one another.

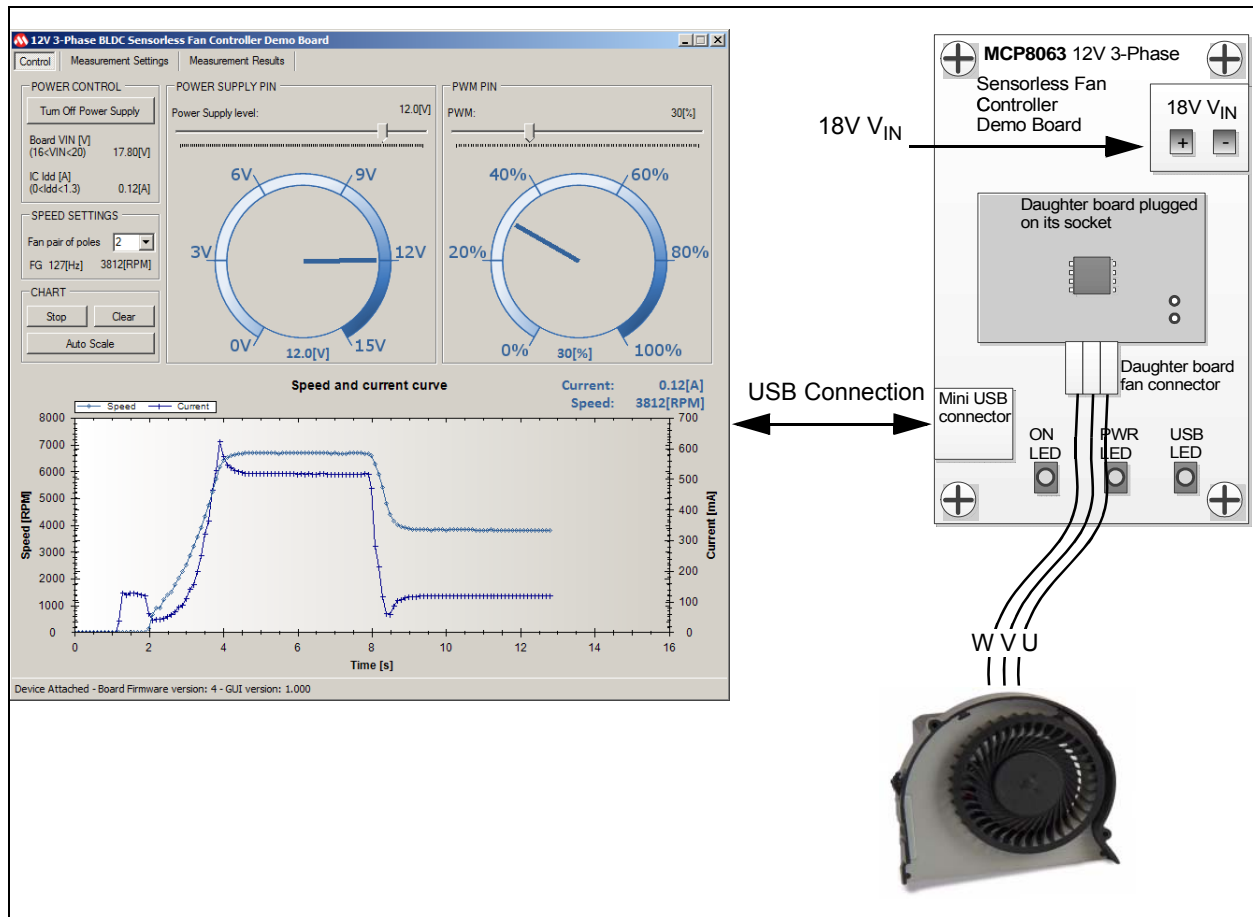

FIGURE 1-3: System Overview.

1.3 WHAT THE MTD6501D 12V 3-PHASE BLDC SENSORLESS FAN CONTROLLER DAUGHTER BOARD KIT INCLUDES

Depending on the daughter board version, the MTD6501D 12V 3-Phase BLDC Sensorless Fan Controller Daughter Board Kit includes:

- MTD6501D Daughter Board (ADM00533)
- Important Information Sheet

NOTES:

Chapter 2. Installation and Operation

2.1 GETTING STARTED

In Standalone mode, a power supply (2V to 14V) is required to supply the board using the VCC and the GND connector to operate with the daughter boards. Ensure that the power supply can provide enough current for the application (maximum is 800 mA).

A function generator with the frequency range of 0.02 kHz to 100 kHz can be used for the PWM pin. The PWM pin can be driven open-drain (internal pull) or logic 0V-3V. The PWM pin can be left open in order to operate with a PWM = 100%. The FG pin allows the electrical speed of the motor to be read. The assembled R1 resistor is used as a pull-up to VDD, so the signal will switch between 0V and 3V.

Verify if the Boost pin has to be enabled. To enable the Boost pin, a 0Ω resistor should be assembled on the board in the R2 location. If the Boost pin does not need to be enabled, R2 should remain unpopulated. See the MTD6501 Data Sheet (DS22263B) for more information about the Boost pin. Connect the 3-phase BLDC motor before enabling the power supply.

Figure 2-1 shows the connection to operate the MTD6501 Daughter Board.

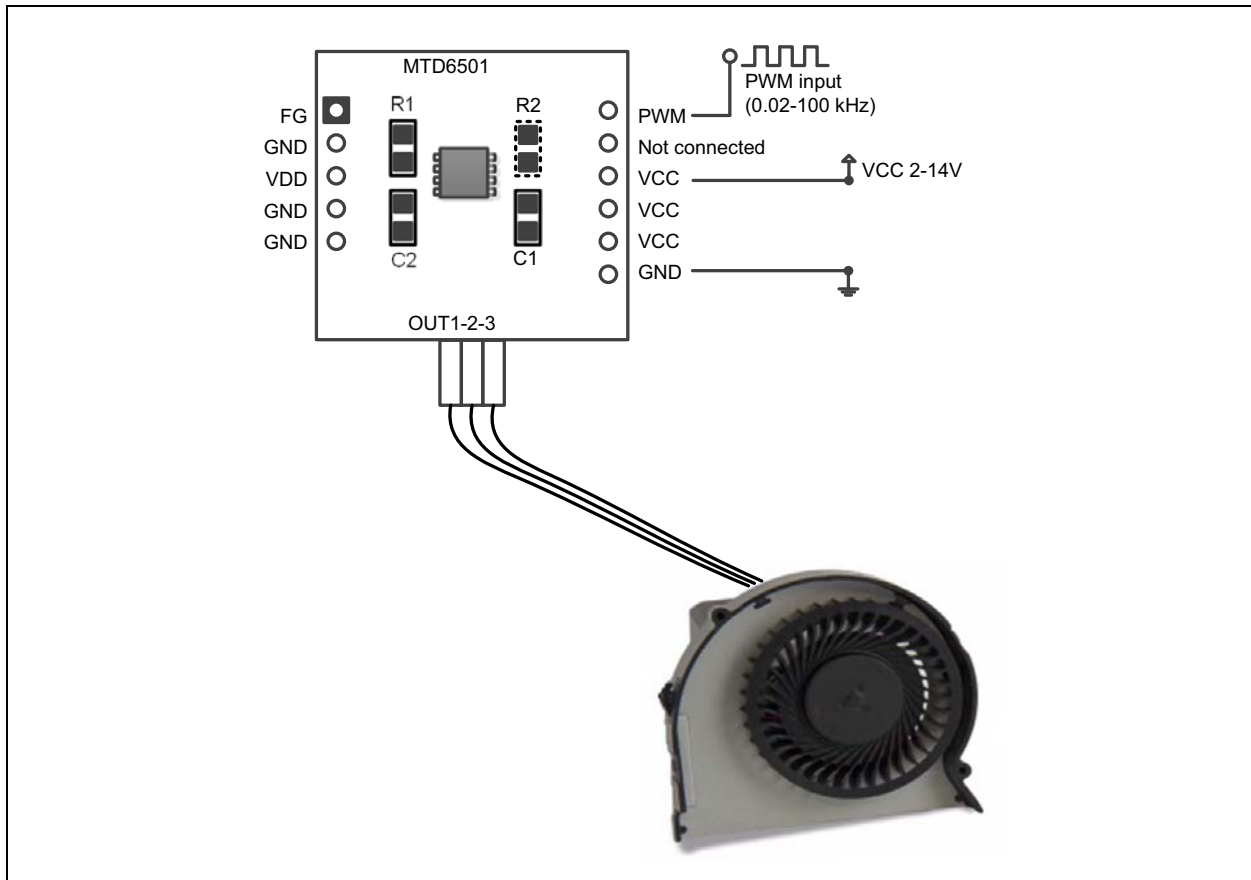

FIGURE 2-1: MTD6501 Daughter Board Operation.

NOTES:



MTD6501D 12V 3-PHASE BLDC SENSORLESS FAN CONTROLLER DAUGHTER BOARD USER'S GUIDE

Appendix A. Schematics and Layouts

A.1 INTRODUCTION

This appendix contains the schematics and layouts for the following device which is included in the MTD6501 12V 3-Phase BLDC Sensorless Fan Controller Daughter Board:

- **MTD6501D Daughter Board (ADM00533)**
 - [MTD6501D Daughter Board – Schematic](#)
 - [MTD6501D Daughter Board – Top Silk](#)
 - [MTD6501D Daughter Board – Top Copper and Silk](#)
 - [MTD6501D Daughter Board – Top Copper](#)
 - [MTD6501D Daughter Board – Bottom Copper](#)
 - [MTD6501D Daughter Board – Bottom Copper and Silk](#)
 - [MTD6501D Daughter Board – Bottom Silk](#)

A.2 MTD6501D DAUGHTER BOARD – SCHEMATIC

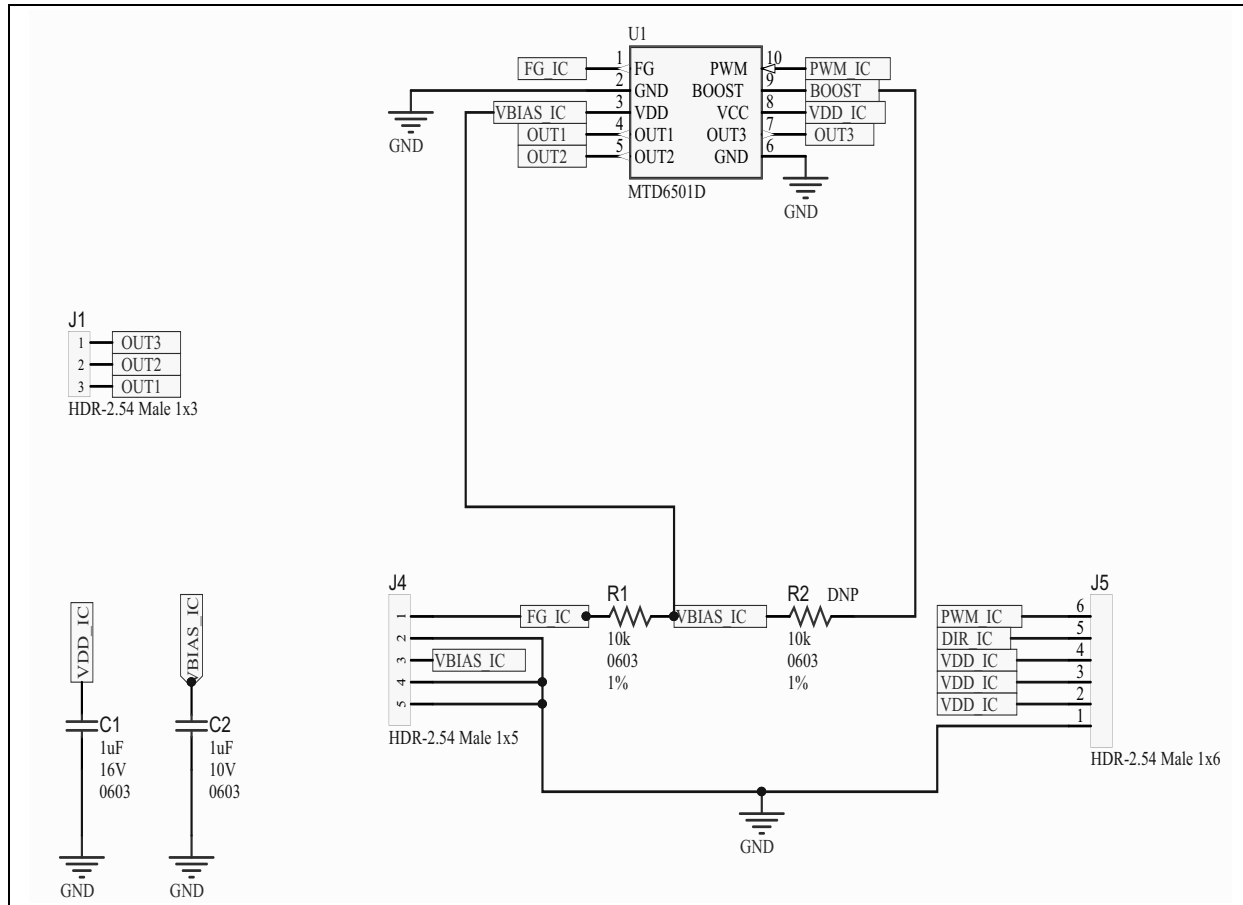

A.3 MTD6501D DAUGHTER BOARD – TOP SILK

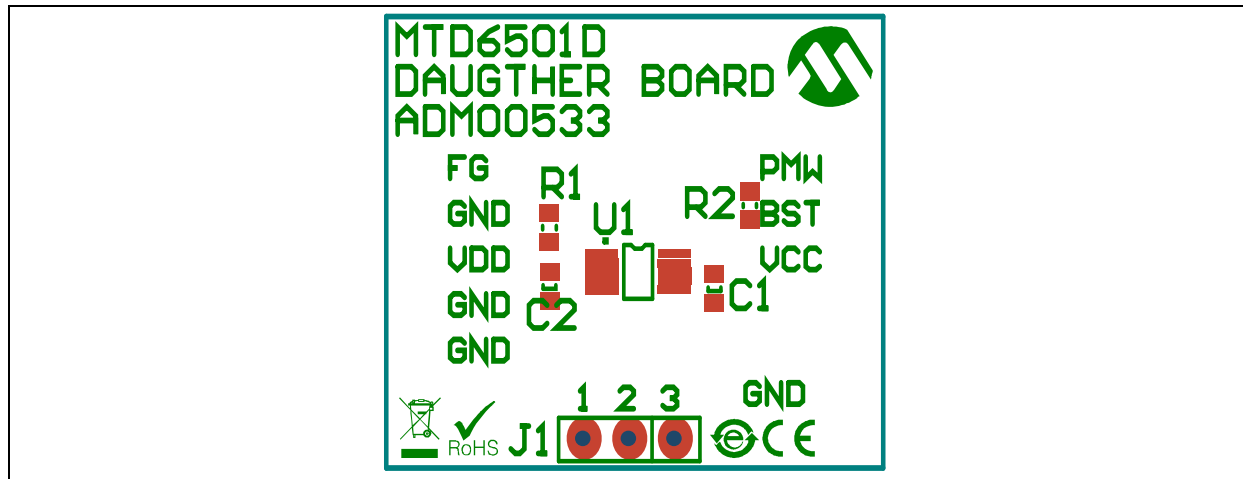

A.4 MTD6501D DAUGHTER BOARD – TOP COPPER AND SILK

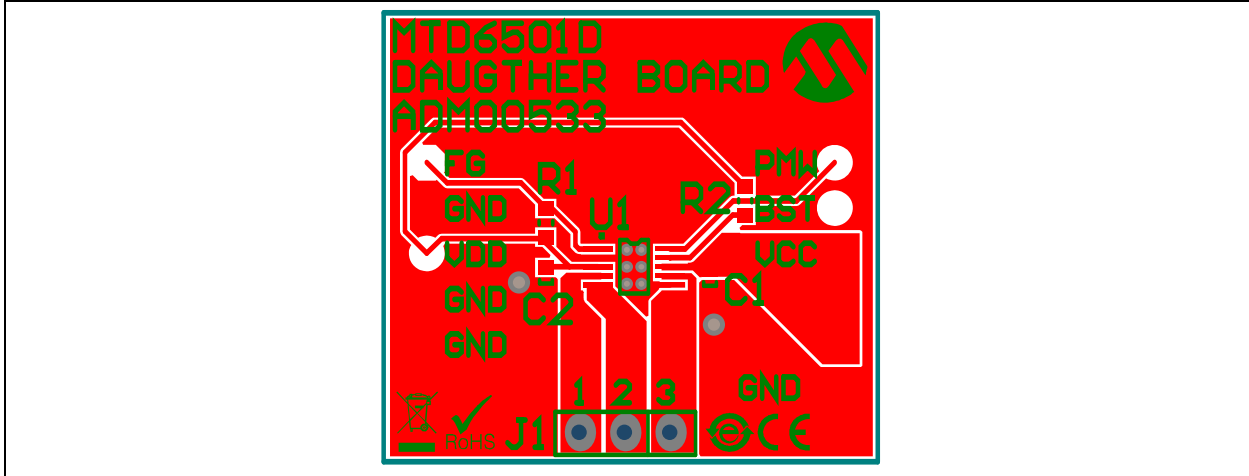

A.5 MTD6501D DAUGHTER BOARD – TOP COPPER

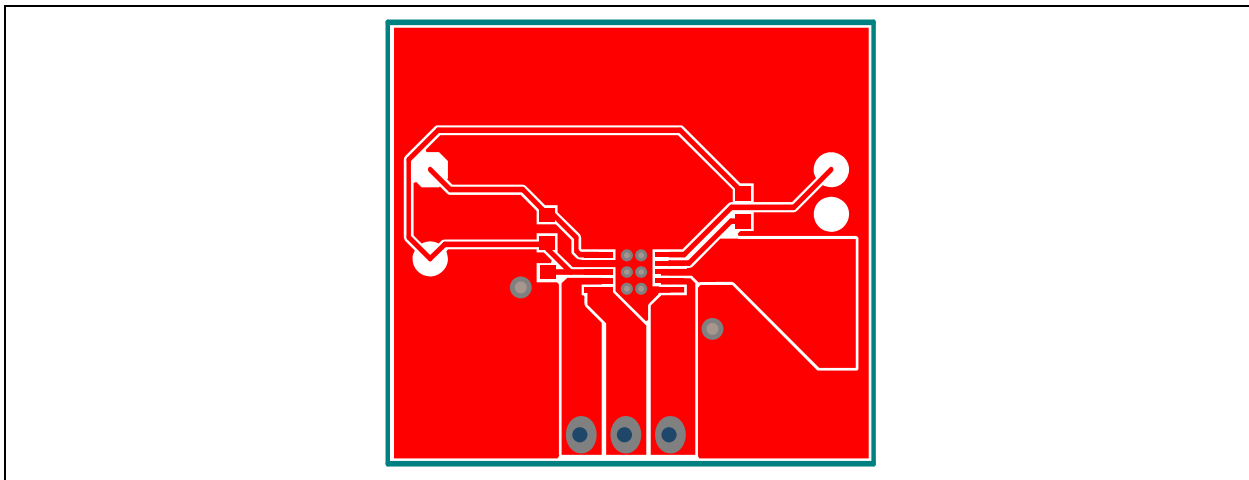

A.6 MTD6501D DAUGHTER BOARD – BOTTOM COPPER

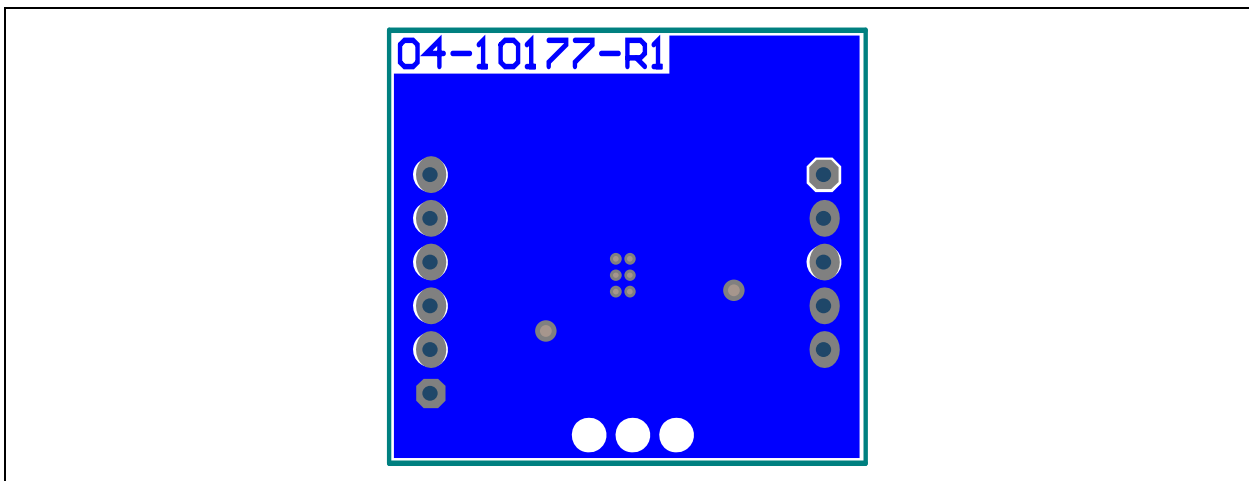

A.7 MTD6501D DAUGHTER BOARD – BOTTOM COPPER AND SILK

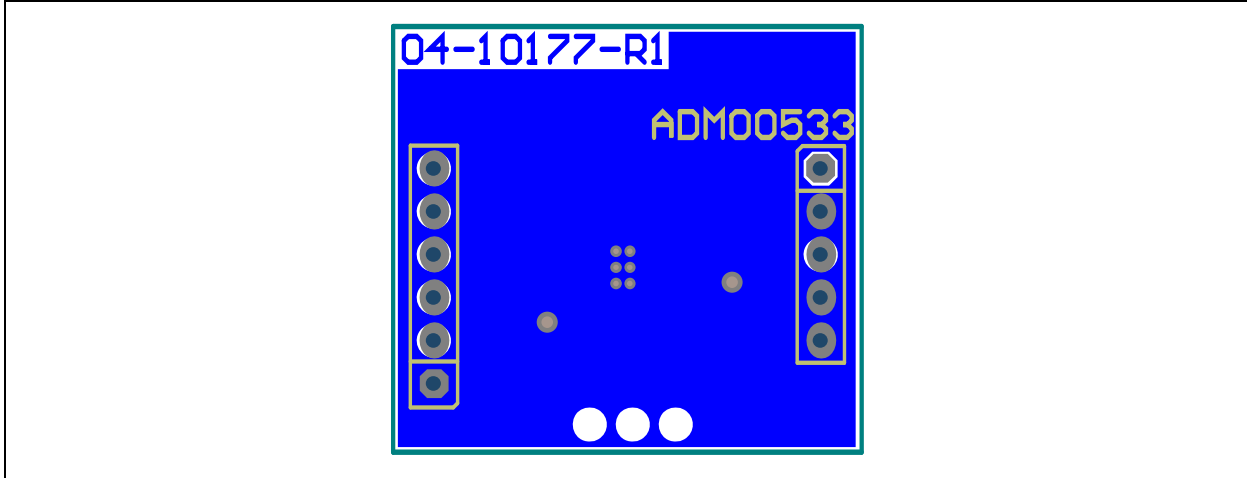

A.8 MTD6501D DAUGHTER BOARD – BOTTOM SILK

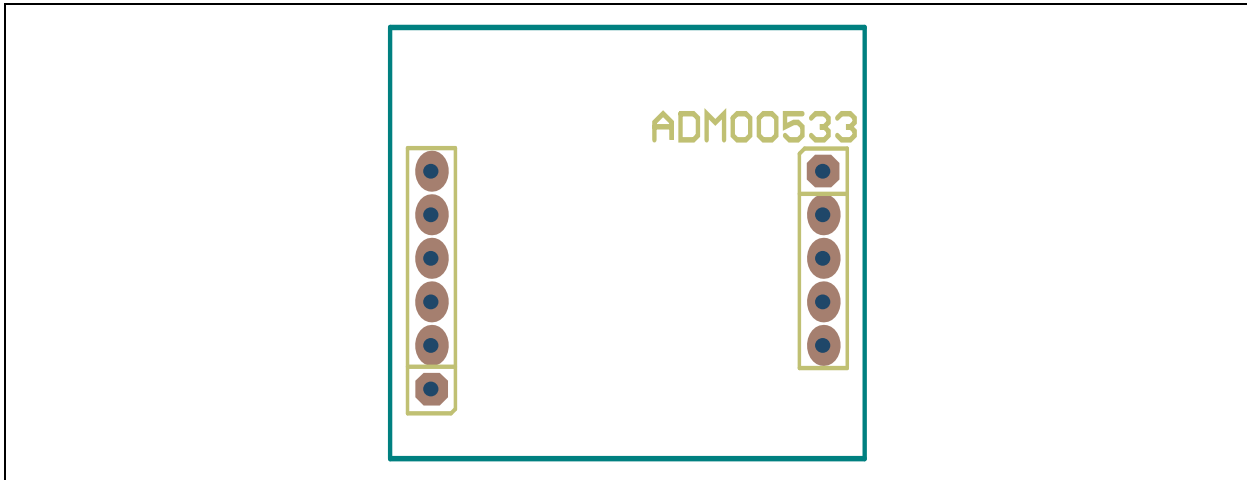



**MTD6501D 12V 3-PHASE BLDC SENSORLESS
FAN CONTROLLER DAUGHTER BOARD
USER'S GUIDE**

Appendix B. Bill of Materials (BOM)

TABLE B-1: BILL OF MATERIALS (BOM) - MTD6501D DAUGHTER BOARD (ADM00533)

Qty	Reference	Description	Manufacturer	Part Number
1	C1	Capacitor ceramic 1 μ F 16V 10% X7R SMD 0603	Taiyo Yuden Co., Ltd.	EMK107B7105KA-T
1	C2	Capacitor ceramic 1 μ F 10V 20% X7R SMD 0603	TDK Corporation	C1608X7R1A105M
1	J1	Connector Header-2.54 Male 1x3 Tin 6.2 MH TH R/A	Molex [®]	0022288030
1	J4	Connector Header-2.54 Male 1x5 Gold 5.84 MH TH vertical	Samtec, Inc.	TSW-105-07-S-S
1	J5	Connector Header-2.54 Male 1x6 Gold 5.84 MH TH vertical	FCI	68001-106HLF
1	PCB1	Printed Circuit Board	—	04-10432
1	R1	Resistor TKF 10k 1% 1/16W SMD 0603	SPC Technology	MCHP03W8F1002T5E
1	U1	Microchip Analog Motor Driver MTD6501D-HC1 SOP-8	Microchip Technology, Inc.	MTD6501D-HC1

Note 1: The components listed in this Bill of Materials are representative of the PCB assembly. The released BOM used in manufacturing uses all RoHS-compliant components.



MICROCHIP

Worldwide Sales and Service

AMERICAS

Corporate Office
2355 West Chandler Blvd.
Chandler, AZ 85224-6199
Tel: 480-792-7200
Fax: 480-792-7277
Technical Support:
<http://www.microchip.com/support>
Web Address:
www.microchip.com

Atlanta
Duluth, GA
Tel: 678-957-9614
Fax: 678-957-1455

Austin, TX
Tel: 512-257-3370

Boston
Westborough, MA
Tel: 774-760-0087
Fax: 774-760-0088

Chicago
Itasca, IL
Tel: 630-285-0071
Fax: 630-285-0075

Cleveland
Independence, OH
Tel: 216-447-0464
Fax: 216-447-0643

Dallas
Addison, TX
Tel: 972-818-7423
Fax: 972-818-2924

Detroit
Novi, MI
Tel: 248-848-4000

Houston, TX
Tel: 281-894-5983

Indianapolis
Noblesville, IN
Tel: 317-773-8323
Fax: 317-773-5453

Los Angeles
Mission Viejo, CA
Tel: 949-462-9523
Fax: 949-462-9608

New York, NY
Tel: 631-435-6000

San Jose, CA
Tel: 408-735-9110

Canada - Toronto
Tel: 905-695-1980
Fax: 905-695-2078

ASIA/PACIFIC

Asia Pacific Office
Suites 3707-14, 37th Floor
Tower 6, The Gateway
Harbour City, Kowloon

Hong Kong
Tel: 852-2943-5100
Fax: 852-2401-3431

Australia - Sydney
Tel: 61-2-9868-6733
Fax: 61-2-9868-6755

China - Beijing
Tel: 86-10-8569-7000
Fax: 86-10-8528-2104

China - Chengdu
Tel: 86-28-8665-5511
Fax: 86-28-8665-7889

China - Chongqing
Tel: 86-23-8980-9588
Fax: 86-23-8980-9500

China - Dongguan
Tel: 86-769-8702-9880

China - Guangzhou
Tel: 86-20-8755-8029

China - Hangzhou
Tel: 86-571-8792-8115
Fax: 86-571-8792-8116

China - Hong Kong SAR
Tel: 852-2943-5100
Fax: 852-2401-3431

China - Nanjing
Tel: 86-25-8473-2460
Fax: 86-25-8473-2470

China - Qingdao
Tel: 86-532-8502-7355
Fax: 86-532-8502-7205

China - Shanghai
Tel: 86-21-5407-5533
Fax: 86-21-5407-5066

China - Shenyang
Tel: 86-24-2334-2829
Fax: 86-24-2334-2393

China - Shenzhen
Tel: 86-755-8864-2200
Fax: 86-755-8203-1760

China - Wuhan
Tel: 86-27-5980-5300
Fax: 86-27-5980-5118

China - Xian
Tel: 86-29-8833-7252
Fax: 86-29-8833-7256

ASIA/PACIFIC

China - Xiamen
Tel: 86-592-2388138
Fax: 86-592-2388130

China - Zhuhai
Tel: 86-756-3210040
Fax: 86-756-3210049

India - Bangalore
Tel: 91-80-3090-4444
Fax: 91-80-3090-4123

India - New Delhi
Tel: 91-11-4160-8631
Fax: 91-11-4160-8632

India - Pune
Tel: 91-20-3019-1500

Japan - Osaka
Tel: 81-6-6152-7160
Fax: 81-6-6152-9310

Japan - Tokyo
Tel: 81-3-6880-3770
Fax: 81-3-6880-3771

Korea - Daegu
Tel: 82-53-744-4301
Fax: 82-53-744-4302

Korea - Seoul
Tel: 82-2-554-7200
Fax: 82-2-558-5932 or
82-2-558-5934

Malaysia - Kuala Lumpur
Tel: 60-3-6201-9857
Fax: 60-3-6201-9859

Malaysia - Penang
Tel: 60-4-227-8870
Fax: 60-4-227-4068

Philippines - Manila
Tel: 63-2-634-9065
Fax: 63-2-634-9069

Singapore
Tel: 65-6334-8870
Fax: 65-6334-8850

Taiwan - Hsin Chu
Tel: 886-3-5778-366
Fax: 886-3-5770-955

Taiwan - Kaohsiung
Tel: 886-7-213-7828

Taiwan - Taipei
Tel: 886-2-2508-8600
Fax: 886-2-2508-0102

Thailand - Bangkok
Tel: 66-2-694-1351
Fax: 66-2-694-1350

EUROPE

Austria - Wels
Tel: 43-7242-2244-39
Fax: 43-7242-2244-393

Denmark - Copenhagen
Tel: 45-4450-2828
Fax: 45-4485-2829

France - Paris
Tel: 33-1-69-53-63-20
Fax: 33-1-69-30-90-79

Germany - Dusseldorf
Tel: 49-2129-3766400

Germany - Karlsruhe
Tel: 49-721-625370

Germany - Munich
Tel: 49-89-627-144-0
Fax: 49-89-627-144-44

Italy - Milan
Tel: 39-0331-742611
Fax: 39-0331-466781

Italy - Venice
Tel: 39-049-7625286

Netherlands - Drunen
Tel: 31-416-690399
Fax: 31-416-690340

Poland - Warsaw
Tel: 48-22-3325737

Spain - Madrid
Tel: 34-91-708-08-90
Fax: 34-91-708-08-91

Sweden - Stockholm
Tel: 46-8-5090-4654

UK - Wokingham
Tel: 44-118-921-5800
Fax: 44-118-921-5820

06/23/16