



MPLAB Starter Kit for PIC24F User's Guide

Note the following details of the code protection feature on Microchip devices:

- Microchip products meet the specification contained in their particular Microchip Data Sheet.
- Microchip believes that its family of products is one of the most secure families of its kind on the market today, when used in the intended manner and under normal conditions.
- There are dishonest and possibly illegal methods used to breach the code protection feature. All of these methods, to our knowledge, require using the Microchip products in a manner outside the operating specifications contained in Microchip's Data Sheets. Most likely, the person doing so is engaged in theft of intellectual property.
- Microchip is willing to work with the customer who is concerned about the integrity of their code.
- Neither Microchip nor any other semiconductor manufacturer can guarantee the security of their code. Code protection does not mean that we are guaranteeing the product as "unbreakable."

Code protection is constantly evolving. We at Microchip are committed to continuously improving the code protection features of our products. Attempts to break Microchip's code protection feature may be a violation of the Digital Millennium Copyright Act. If such acts allow unauthorized access to your software or other copyrighted work, you may have a right to sue for relief under that Act.

Information contained in this publication regarding device applications and the like is provided only for your convenience and may be superseded by updates. It is your responsibility to ensure that your application meets with your specifications. MICROCHIP MAKES NO REPRESENTATIONS OR WARRANTIES OF ANY KIND WHETHER EXPRESS OR IMPLIED, WRITTEN OR ORAL, STATUTORY OR OTHERWISE, RELATED TO THE INFORMATION, INCLUDING BUT NOT LIMITED TO ITS CONDITION, QUALITY, PERFORMANCE, MERCHANTABILITY OR FITNESS FOR PURPOSE. Microchip disclaims all liability arising from this information and its use. Use of Microchip devices in life support and/or safety applications is entirely at the buyer's risk, and the buyer agrees to defend, indemnify and hold harmless Microchip from any and all damages, claims, suits, or expenses resulting from such use. No licenses are conveyed, implicitly or otherwise, under any Microchip intellectual property rights.

Trademarks

The Microchip name and logo, the Microchip logo, Accuron, dsPIC, KEELOQ, KEELOQ logo, MPLAB, PIC, PICmicro, PICSTART, PRO MATE, rPIC and SmartShunt are registered trademarks of Microchip Technology Incorporated in the U.S.A. and other countries.

FilterLab, Linear Active Thermistor, MXDEV, MXLAB, SEEVAL, SmartSensor and The Embedded Control Solutions Company are registered trademarks of Microchip Technology Incorporated in the U.S.A.

Analog-for-the-Digital Age, Application Maestro, CodeGuard, dsPICDEM, dsPICDEM.net, dsPICworks, dsSPEAK, ECAN, ECONOMONITOR, FanSense, In-Circuit Serial Programming, ICSP, ICEPIC, Mindi, MiWi, MPASM, MPLAB Certified logo, MPLIB, MPLINK, mTouch, PICkit, PICDEM, PICDEM.net, PICTail, PIC³² logo, PowerCal, PowerInfo, PowerMate, PowerTool, REAL ICE, rLAB, Select Mode, Total Endurance, UNI/O, WiperLock and ZENA are trademarks of Microchip Technology Incorporated in the U.S.A. and other countries.

SQTP is a service mark of Microchip Technology Incorporated in the U.S.A.

All other trademarks mentioned herein are property of their respective companies.

© 2008, Microchip Technology Incorporated, Printed in the U.S.A., All Rights Reserved.

 Printed on recycled paper.

**QUALITY MANAGEMENT SYSTEM
CERTIFIED BY DNV
== ISO/TS 16949:2002 ==**

Microchip received ISO/TS-16949:2002 certification for its worldwide headquarters, design and wafer fabrication facilities in Chandler and Tempe, Arizona; Gresham, Oregon and design centers in California and India. The Company's quality system processes and procedures are for its PIC[®] MCUs and dsPIC[®] DSCs, KEELOQ[®] code hopping devices, Serial EEPROMs, microperipherals, nonvolatile memory and analog products. In addition, Microchip's quality system for the design and manufacture of development systems is ISO 9001:2000 certified.

Table of Contents

Preface	1
Chapter 1. Introduction to the Starter Kit	
1.1 Overview	7
1.2 Operational Requirements	7
1.3 Initial Board Setup	8
Chapter 2. The Demonstration Application	
2.1 Features Used Throughout the Demo Application	9
2.2 Specific Demo Highlights	11
Chapter 3. Configuring the Starter Kit Hardware	
3.1 Overview	15
3.2 Starter Kit Configurations	15
Chapter 4. Developing an Application	
4.1 Setting Up an Example Application for Debug	20
4.2 Running the Example Application	21
4.3 Debugging the Example Application	21
4.4 Programming the Debugged Application	24
4.5 Creating Other Applications	24
4.6 Determining Device Support and Reserved Resources	24
4.7 Debug Version Information	24
4.8 Troubleshooting	25
Chapter 5. Hardware	
5.1 Application Functional Overview	27
5.2 Programmer/Debugger Functional Overview	28
5.3 Board Components	29
Appendix A. Starter Kit Schematics	31
Index	37
Worldwide Sales and Service	38

MPLAB Starter Kit for PIC24F User's Guide

NOTES:

Preface

NOTICE TO CUSTOMERS

All documentation becomes dated, and this manual is no exception. Microchip tools and documentation are constantly evolving to meet customer needs, so some actual dialogs and/or tool descriptions may differ from those in this document. Please refer to our web site (www.microchip.com) to obtain the latest documentation available.

Documents are identified with a “DS” number. This number is located on the bottom of each page, in front of the page number. The numbering convention for the DS number is “DSXXXXA”, where “XXXX” is the document number and “A” is the revision level of the document.

For the most up-to-date information on development tools, see the MPLAB® IDE online help. Select the Help menu, and then Topics to open a list of available online help files.

INTRODUCTION

This chapter contains general information that will be useful to know before you use the MPLAB Starter Kit for PIC24F. Items discussed in this chapter include:

- Document Layout
- Conventions Used in this Guide
- Warranty Registration
- Recommended Reading
- The Microchip Web Site
- Development Systems Customer Change Notification Service
- Customer Support
- Document Revision History

DOCUMENT LAYOUT

This document describes how to use the starter kit as a development and demonstrative tool for PIC24F MCU device capabilities and features. The manual layout is as follows:

- **Chapter 1. Introduction to the Starter Kit** – This chapter introduces the starter kit and provides an overview of its features.
- **Chapter 2. The Demonstration Application** – This chapter describes the preprogrammed PIC24F demo application.
- **Chapter 3. Configuring the Starter Kit Hardware** – This chapter describes the different USB and power configurations available with the starter kit.
- **Chapter 4. Developing an Application** – This chapter describes how to debug application software on the starter kit using MPLAB® IDE.
- **Chapter 5. Hardware** – This chapter provides a functional overview of the starter kit and identifies the major hardware components.
- **Appendix A. Starter Kit Schematics** – This appendix provides detailed schematic diagrams of the starter kit.

MPLAB Starter Kit for PIC24F User's Guide

CONVENTIONS USED IN THIS GUIDE

This manual uses the following documentation conventions:

DOCUMENTATION CONVENTIONS

Description	Represents	Examples
Arial font:		
Italic characters	Referenced books	<i>MPLAB® IDE User's Guide</i>
	Emphasized text	...is the <i>only</i> compiler...
Initial caps	A window	the Output window
	A dialog	the Settings dialog
	A menu selection	select Enable Programmer
Quotes	A field name in a window or dialog	"Save project before build"
Underlined, italic text with right angle bracket	A menu path	<u><i>File>Save</i></u>
Bold characters	A dialog button	Click OK
	A tab	Click the Power tab
Text in angle brackets < >	A key on the keyboard	Press <Enter>, <F1>
Courier New font:		
Plain Courier New	Sample source code	<code>#define START</code>
	Filenames	<code>autoexec.bat</code>
	File paths	<code>c:\mcc18\h</code>
	Keywords	<code>_asm, _endasm, static</code>
	Command-line options	<code>-Opa+, -Opa-</code>
	Bit values	<code>0, 1</code>
	Constants	<code>0xFF, 'A'</code>
Italic Courier New	A variable argument	<i>file.o</i> , where <i>file</i> can be any valid filename
Square brackets []	Optional arguments	<code>mcc18 [options] file [options]</code>
Curly brackets and pipe character: { }	Choice of mutually exclusive arguments; an OR selection	<code>errorlevel {0 1}</code>
Ellipses...	Replaces repeated text	<code>var_name [, var_name...]</code>
	Represents code supplied by user	<code>void main (void) { ... }</code>

WARRANTY REGISTRATION

Please complete the enclosed Warranty Registration Card and mail it promptly. Sending in the Warranty Registration Card entitles you to receive new product updates. Interim software releases are available at the Microchip web site.

RECOMMENDED READING

This user's guide describes how to use the MPLAB Starter Kit for PIC24F. Other useful documents are listed below. The following Microchip documents are available and recommended as supplemental reference resources.

Readme Files

For the latest information on using other tools, read the tool-specific Readme files in the Readmes subdirectory of the MPLAB IDE installation directory. The Readme files contain update information and known issues that may not be included in this user's guide.

PIC24F Family Reference Manual

This reference manual explains the operation of the PIC24F microcontroller family architecture and peripheral modules. The specifics of each device family are discussed in the individual family's device data sheet.

This useful manual is on-line in sections at the Technical Documentation section of the Microchip web site. Refer to these for detailed information on PIC24F device operation.

Device Data Sheets and Flash Programming Specifications

Refer to the appropriate device Data Sheet for device-specific information and specifications. Also, refer to the appropriate device Flash Programming Specification for information on instruction sets and firmware development. These files may be found on the Microchip web site or from your local sales office.

MPLAB[®] ASM30, MPLAB[®] LINK30 and Utilities User's Guide (DS51317)

This document helps you use Microchip Technology's language tools for PIC24F devices based on GNU technology. The language tools discussed are the MPLAB ASM30 Assembler, MPLAB LINK30 Linker, MPLAB LIB30 Archiver/Librarian and other 16-bit device utilities.

MPLAB[®] C30 C Compiler User's Guide (DS51284)

This document helps you use Microchip's MPLAB C30 C compiler to develop your application. MPLAB C30 is a GNU-based language tool, based on source code from the Free Software Foundation (FSF). For more information about FSF, see www.fsf.org.

MPLAB[®] IDE User's Guide (DS51519)

This document describes how to use the MPLAB IDE integrated development environment, as well as the MPLAB IDE Project Manager, MPLAB IDE Editor and MPLAB SIM Simulator. Use these development tools to help you develop and debug application code.

MPLAB Starter Kit for PIC24F User's Guide

THE MICROCHIP WEB SITE

Microchip provides online support via our web site at www.microchip.com. This web site is used as a means to make files and information easily available to customers. Accessible by using your favorite Internet browser, the web site contains the following information:

- **Product Support** – Data sheets and errata, application notes and sample programs, design resources, user's guides and hardware support documents, latest software releases and archived software
- **General Technical Support** – Frequently Asked Questions (FAQs), technical support requests, online discussion groups, Microchip consultant program member listing
- **Business of Microchip** – Product selector and ordering guides, latest Microchip press releases, listing of seminars and events, listings of Microchip sales offices, distributors and factory representatives

DEVELOPMENT SYSTEMS CUSTOMER CHANGE NOTIFICATION SERVICE

Microchip's customer notification service helps keep customers current on Microchip products. Subscribers will receive e-mail notification whenever there are changes, updates, revisions or errata related to a specified product family or development tool of interest.

To register, access the Microchip web site at www.microchip.com, click on Customer Change Notification and follow the registration instructions.

The Development Systems product group categories are:

- **Compilers** – The latest information on Microchip C compilers and other language tools. These include the MPLAB C18 and MPLAB C30 C compilers; MPASM™ and MPLAB ASM30 assemblers; MPLINK™ and MPLAB LINK30 object linkers; and MPLIB™ and MPLAB LIB30 object librarians.
- **In-Circuit Emulators** – The latest information on Microchip in-circuit emulators. These include the MPLAB REAL ICE™ and MPLAB ICE 2000 in-circuit emulators.
- **In-Circuit Debuggers** – The latest information on Microchip in-circuit debuggers. These include MPLAB ICD 2 and PICKit™ 2.
- **MPLAB IDE** – The latest information on Microchip MPLAB IDE, the Windows® Integrated Development Environment for development systems tools. This list is focused on the MPLAB IDE, MPLAB IDE Project Manager, MPLAB IDE Editor and MPLAB SIM Simulator, as well as general editing and debugging features.
- **Programmers** – The latest information on Microchip programmers. These include the MPLAB PM3 device programmer and the PICSTART® Plus and PICKit 1 and 2 development programmers.

CUSTOMER SUPPORT

Users of Microchip products can receive assistance through several channels:

- Distributor or Representative
- Local Sales Office
- Field Application Engineer (FAE)
- Technical Support

Customers should contact their distributor, representative or field application engineer (FAE) for support. Local sales offices are also available to help customers. A listing of sales offices and locations is included in the back of this document.

Technical support is available through the web site at: <http://support.microchip.com>

DOCUMENT REVISION HISTORY

Revision A (March 2008)

- Initial Release of this Document

MPLAB Starter Kit for PIC24F User's Guide

NOTES:

Chapter 1. Introduction to the Starter Kit

Thank you for purchasing Microchip Technology's MPLAB Starter Kit for PIC24F. This board is intended to introduce and demonstrate the capabilities and features of PIC24F microcontrollers. In addition, the starter kit has on-board in-circuit debug circuitry so that you may develop and debug your own applications.

This chapter introduces the starter kit and provides an overview of its features. Topics covered include:

- Overview
- Operational Requirements
- Initial Board Setup

1.1 OVERVIEW

The MPLAB Starter Kit for PIC24F provides an all-in-one solution for debugging and programming applications using Microchip's own MPLAB Integrated Development Environment (IDE). A USB connection to a host computer supplies communications and power to the board; no additional external power supply is needed. For independent host-side USB operation, the starter kit may be disconnected from the PC and powered at test points for independent functionality.

The starter kit includes integrated debug and programmer circuitry that allows applications to be programmed onto the board's PIC24F MCU device and then debugged, all using MPLAB IDE. The need for an additional programmer or hardware interface has been completely eliminated.

The application side of the starter kit contains a range of hardware components to demonstrate the utility and processing power of Microchip's PIC24F family of 16-bit microcontrollers.

1.2 OPERATIONAL REQUIREMENTS

To communicate with and program the MPLAB Starter Kit for PIC24F, the following hardware and software requirements must be met:

- PC compatible system with CD-ROM drive
- One available USB port on the PC, or a powered USB hub
- Microsoft® Windows® 2000 SP4, Windows XP SP2, or Windows Vista™ (32-bit)

Note: Only initial testing has been performed on 32-bit Windows Vista for this release. The 64-bit version is not supported at this time.

In addition, the following is needed for some of the application demos:

- USB Flash Drive (not included)

1.3 INITIAL BOARD SETUP

With its pre-installed demo application, the MPLAB Starter Kit for PIC24F is designed to be used straight out of the box. Except for a single connection to a computer, no additional hardware or configuration is necessary.

1.3.1 Installing the Software

Before connecting the starter kit to any computer for the first time, it is very important to install the accompanying software on the MPLAB Starter Kit for PIC24F CD first. This ensures that the proper USB drivers for communicating with the starter kit programmer/debugger are installed and ready to recognize the board.

To install the software and driver, insert the starter kit CD into the CD-ROM drive. The installation process starts automatically. The process pauses for user responses to accept the Microchip software licenses and to confirm the installation directories; respond appropriately.

1.3.2 Connecting the Hardware

Once the starter kit software is installed, connect the provided USB cable (A to mini-B) to any available USB port on the PC or powered hub, then to the starter kit at the mini-B receptacle, J1, on the programmer/debugger side of the board (Figure 1-1). The PC USB connection provides communication and power to the board. A USB Flash drive, used for portions of the demo application, may be connected to the starter kit at any time.

If the cable is connected correctly, the green Power and Target Power LEDs (D2 and D4) are lit. LED1 displays a reversed raster and start-up screen, while the tri-color LED cycles through a sequence of colors. After this power-on sequence, LED1 will display the "PIC24F Starter Kit" main menu.

At the same time, a sequence of pop-up balloons in the system tray (lower right of desktop) should appear, stating that (1) new hardware has been found, (2) drivers are being installed and (3) the new hardware is ready for use. If you do not see these messages and the starter kit does not work, try unplugging and reconnecting the USB. If this does not work, refer to **Section 4.8 "Troubleshooting"**.

FIGURE 1-1: STARTER KIT SETUP

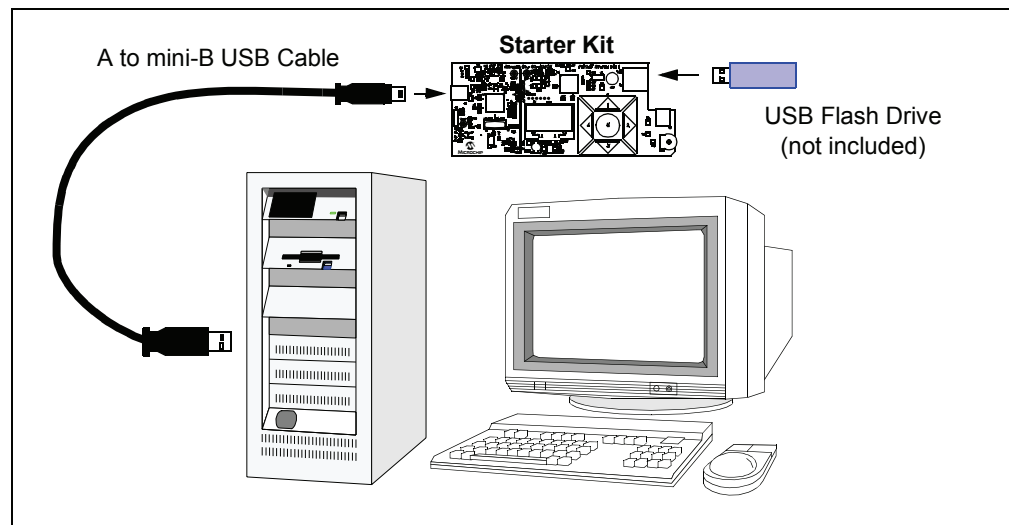

Chapter 2. The Demonstration Application

This chapter describes the demonstration application that is preprogrammed on the PIC24F microcontroller, and how various features highlight the device's processing power and hardware functionality. These include:

- Features Used Throughout the Demo Application:
 - Interactive Display System (Processing Power and Parallel Master Port)
 - Touch Interface (CMTU)
 - Time and Date (RTCC)
- Specific Demo Highlights:
 - RGB LED Control (Three PWMs and Peripheral Pin Select)
 - USB Flash Drive Interface (USB Embedded Host)
 - Real-Time Data Graphing (A/D and Display Multitasking)
 - Real-Time Data Capture (Multitasking with USB Embedded Host)
 - Other Interactive Demos

2.1 FEATURES USED THROUGHOUT THE DEMO APPLICATION

2.1.1 Interactive Display System (Processing Power and Parallel Master Port)

With the exception of input and display hardware, the entire demo application runs on the starter kit's PIC24FJ256GB106 microcontroller, without the need of additional interfaces or external logic for processing support. This microcontroller simultaneously controls and monitors all activities through a processing intensive interactive display system (Figure 2-1).

The microcontroller directly drives the on-board graphics organic LED (OLED) display through its Parallel Master Port (PMP). This is an 8-bit parallel, highly-configurable I/O module that allows users to exchange data with a variety of peripheral devices. In the demo application, the PMP provides the simple data interface needed to control an advanced display device.

Even with a simple visual interface, a graphics display requires a great deal of processing power to maintain and update the display while executing its associated application. At 16 MIPS, the PIC24FJ256GB106 microcontroller has more than enough processing power for this type of application.

FIGURE 2-1: STARTER KIT MENU DISPLAY (MAIN MENU SHOWN)

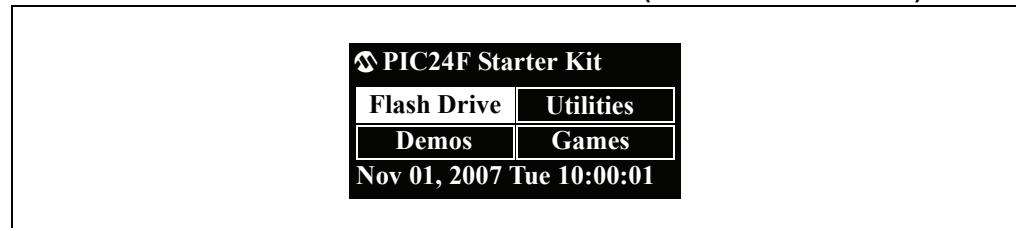

2.1.2 Touch Interface (CMTU)

To control most of the demo application's features, the PIC24F microcontroller uses an on-chip Charge Time Measurement Unit (CTMU) module to implement a capacitive touch-sensitive touch pad on the starter kit board. The CTMU allows the microcontroller to directly sense the touch of a fingertip on the touch pad and interpret this as a control input.

The touch pad (Figure 2-2) is used to select all menu options and input user choices for all options. At each of the menu screens, the up/down arrows (1 and 3) and left/right arrows (2 and 4) serve to highlight a menu option displayed on the OLED, and the center key (5) is used to select the option.

FIGURE 2-2: CAPACITIVE TOUCH PAD

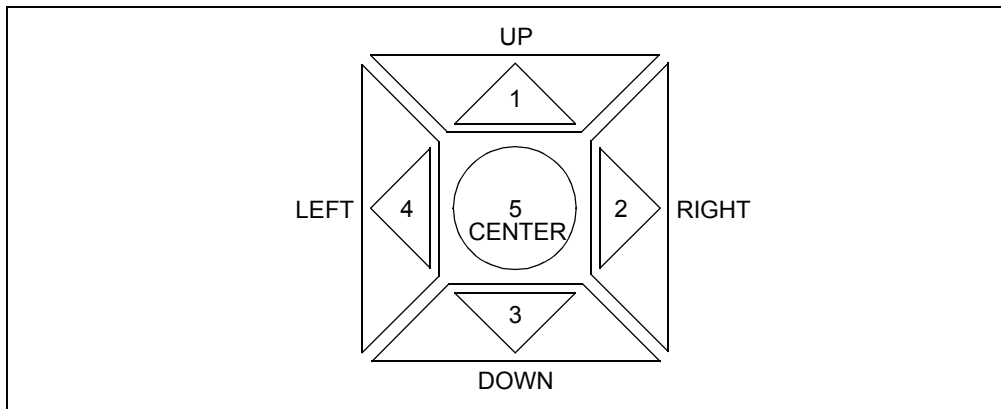

2.1.2.1 TOUCH PAD CALIBRATION

By default, the application is preprogrammed with a CTMU calibration that responds appropriately to the touch of an average person's finger tip. However, there are many factors (ambient temperature and humidity, skin moisture, etc.) that may affect the touch pad's performance. To accommodate these differences, the demo application includes a calibration routine to adjust the touch pad's response.

To run the calibration, select "Utilities" from the main menu, then "Calibrate" from the "Utilities" menu. A series of prompts appears, asking the user to touch and release each individual pad in turn. When the sequence is completed, the "Calibration complete!" message appears. The application automatically returns to the main menu afterwards.

Calibration is reset to the default application value on power-up.

Note: It is important to respond to each prompt as quickly as possible, to maintain contact with a pad until instructed to release it, and to be certain that none of the pads are being touched during the "release" intervals. Otherwise, one or more of the individual pads may be incorrectly calibrated, and the application may act erratically or start responding to "phantom" inputs.

The Demonstration Application

2.1.3 Time and Date (RTCC)

The PIC24F microcontroller has an on-chip Real-Time Clock and Calendar (RTCC) module that the application uses to provide a continuous display of the date and time (in 24-hour format) on the main menu. As the starter kit does not have an on-board battery, the date and time must be set each time power is applied to the board.

To set the RTCC, select “Utilities” from the main menu, then “Date/Time” from the “Utilities” menu. Use the left/right arrow keys to scroll between fields; the border of the selected field becomes bolded. Use the up/down keys to set the value. When finished, press the center touch pad to return directly to the main menu.

FIGURE 2-3: SET DATE/TIME DISPLAY

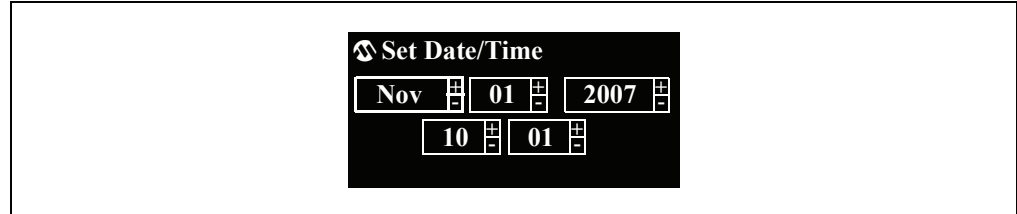

2.2 SPECIFIC DEMO HIGHLIGHTS

2.2.1 RGB LED Control (Three PWMs and Peripheral Pin Select)

Three of the PIC24F microcontroller’s PWM modules control the three-color LED (D6), and can be adjusted to control the LED’s brightness and color. To provide more current to the LED channels and increase brightness, each channel is tied to two of the microcontroller’s output pins. The Peripheral Pin Select feature of PIC24F devices allows users to map the output of a single module (in this case, a PWM) to more than one pin, avoiding any issues of coordinating separate pins in the process. The use of multiple pins for a single PWM is transparent to the rest of the application.

To access this feature, select “Demos” from the Main display, then “RGB LED” from the “Demonstrations menu”. The LED lights up at this point. By default, all three colors are set at their brightness midpoint (Figure 2-4).

Use the up/down touch pads to select a color component, and the left/right touch pads to adjust that color’s intensity. When finished, press the center touch pad to extinguish the LED and return to the main display.

FIGURE 2-4: DEFAULT RGB LED CONTROL DISPLAY

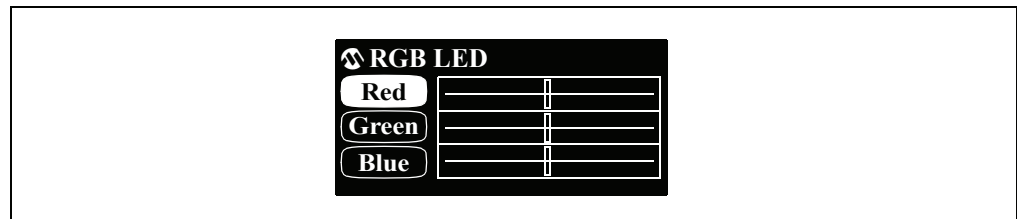

2.2.2 USB Flash Drive Interface (USB Embedded Host)

This demo shows the ability of the PIC24F microcontroller to function as an embedded host by reading data from a USB Flash drive. To access the demo, select “Flash Drive” from the main menu.

If a USB Flash drive with files is plugged in to the USB A-receptacle (J4), the display shows the drive volume name and top level file structure in a list box (Figure 2-5). Long file and directory names are truncated according to earlier Microsoft 8+3 file system conventions (e.g., Longfilename.doc would be truncated as LONGFI~1.doc). Use the up/down arrow keys to scroll through the directory.

Subdirectories are indicated by names with a folder symbol next to them, and are opened by pressing the center touch pad. To move up a directory level, select the “..” entry at the top of the menu window and press the center touch pad.

If a Flash drive is not present, the display shows an empty menu window and the message “Insert media”. If the Flash drive has no content, the display will show only the drive volume name.

To exit the Flash Drive demo and return to the main menu, press the left arrow touch pad.

FIGURE 2-5: TYPICAL DISPLAYS FOR THE FLASH DRIVE INTERFACE

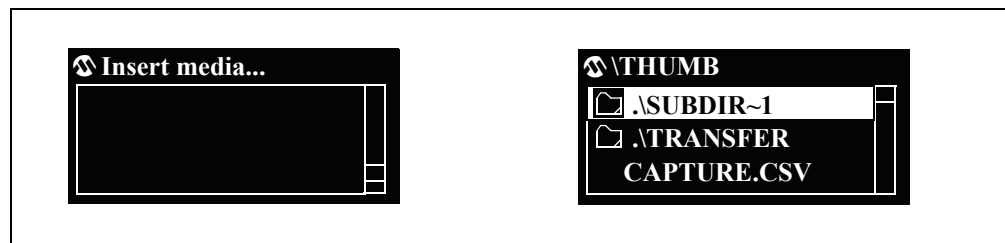

2.2.3 Real-Time Data Graphing (A/D and Display Multitasking)

As an additional demonstration of the application's ability to interact with users in real time, the Data Graphing demo shows the capture and conversion of analog data to graphic information as it happens. In this demo, the input from the potentiometer (R44) is converted by the microcontroller's A/D converter to digital information, and plotted as a time vs. amplitude graph on the OLED display.

To access this demo, select “Demos” from the main menu, then “Graph” from the “Demonstrations” menu. A horizontally scrolling graph appears with a solid line indicating the current position of the potentiometer. Turning the potentiometer through its entire range changes the y-coordinate of the line in real time. At its default setting, the application updates the value from the potentiometer every 100 ms; each time axis division represents approximately 2 seconds. To increase or decrease the graph's update rate, press the right or left arrow touch pads, respectively.

To exit the demo and return to the main menu, press the center touch pad.

FIGURE 2-6: DATA GRAPHING DISPLAY

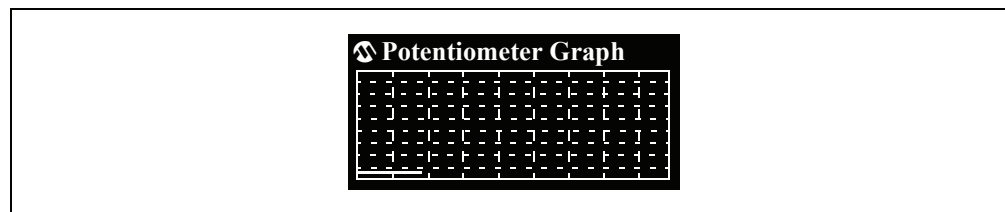

2.2.4 Real-Time Data Capture (Multitasking with USB Embedded Host)

An extension of the Data Graphing demo shows many of the capabilities of the PIC24F microcontroller, all running at the same time: interactive display, multitasking and USB embedded host functionality. This feature allows users not only to graph data and view the results in real time, but also accurately record the results to an external device.

To access this demo, first insert a USB Flash drive into the USB A-receptacle (J4). Select “Demos” from the main menu, then “Capture” from the “Demonstrations” menu. A graph identical in operation to that in the Data Graphing demo appears. (If a Flash drive is not present, a prompt screen will appear instead.) The difference is that the digital value from the potentiometer conversion is written to the Flash drive to a new comma delimited file, `CAPTURE.csv`. Data is written with a second value representing the time of capture. As the application is configured, the capture interval is 10 ms, and is independent of the graphic display’s update rate.

To exit the demo and return to the main menu, press the center touch pad.

FIGURE 2-7: DATA GRAPHING DISPLAYS



2.2.5 Other Interactive Demos

As a final demonstration of the starter kit’s processing power and graphics display capabilities, several other interactive demos are provided for the user to investigate. These are accessed by selecting “Games” from the main menu.

Users may find that the three demos provided (“Shu Box”, “Shapelet” and “Blaster”) similar to some vintage video games. As such, the operations of these demos are regarded to be self-explanatory. Users who require more information will find additional instructions in the comments accompanying the application source code.

MPLAB Starter Kit for PIC24F User's Guide

NOTES:

Chapter 3. Configuring the Starter Kit Hardware

This chapter discusses how to configure the hardware of the MPLAB Starter Kit for PIC24F for various USB prototypes. Topics covered include:

- Overview
- Starter Kit Configurations

3.1 OVERVIEW

In its default configuration, the application side of the starter kit functions as a USB embedded host. Even though the board is drawing power from its connection to the host PC as a bus-powered device, the demo application functions independently of the host PC in communicating with USB peripheral devices.

However, the starter kit can also be used as a platform for developing USB device (peripheral) applications. The mini-B receptacle (J4) on the application side provides the interface for an external USB host.

When setting it up as a prototyping platform, the starter kit board can be configured as either a USB embedded host or a USB device (peripheral). At the same time, the starter kit can be configured to operate with or without the functionality of the programmer/debugger. In terms of the MPLAB IDE environment, we can think of the application as being in Debug or Release mode.

The hardware configurations described here cover the vast majority of cases that the user is likely to see in developing USB applications. Other configurations and USB applications may be possible.

3.2 STARTER KIT CONFIGURATIONS

3.2.1 Embedded Host, Debug Mode

This is the default configuration used when the starter kit is first connected to a host PC (see **Section 1.3 “Initial Board Setup”**). It is also used when USB embedded host applications are still being developed and debugged. In both instances, power to the starter kit is provided through the USB cable.

3.2.2 Device, Debug Mode

In this configuration, application code for a USB device is still being developed and debugged. This requires connections to both the programmer/debugger and application sides of the board, using two A to mini-B USB cables (Figure 3-1):

1. Connected from the host PC to the programmer/debugger (J1).
2. Connected from the host PC to the application side (J5).

The programmer side cable provides the interface to MPLAB IDE, while the application side cable provides the interface between the device and host applications. Both cables provide power to the board.

FIGURE 3-1: STARTER KIT SETUP (DEVICE, DEBUG MODE)

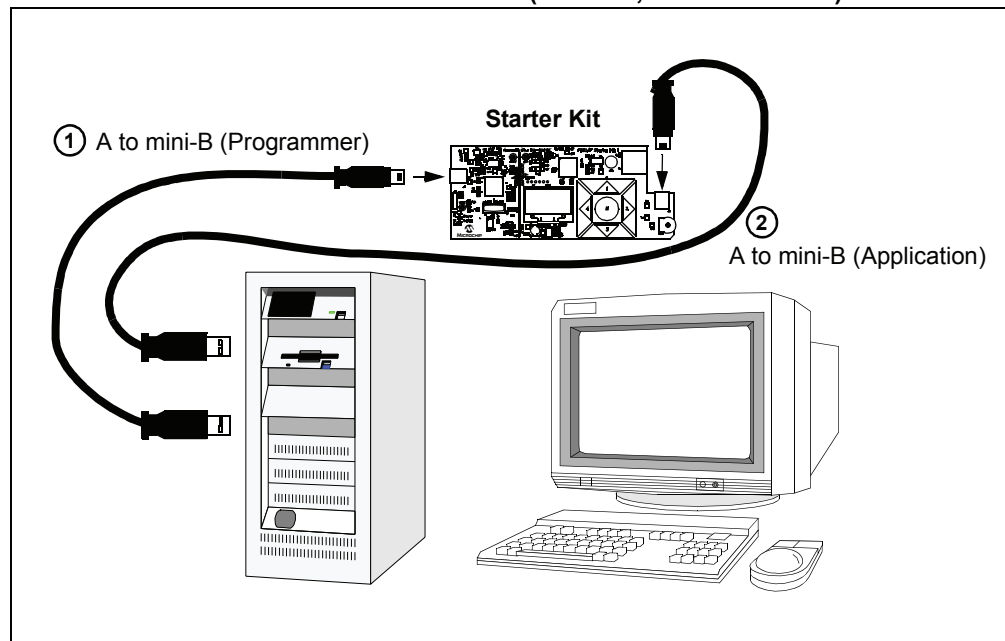

3.2.3 Device, Release Mode

In this configuration, the starter kit has been programmed with a debugged, stand-alone USB device application; programmer/debugger support is not needed. The only connection required is a USB cable between J5 and the host PC (Figure 3-2). The cable provides both power and data connection to the host side application, making it a bus-powered application.

FIGURE 3-2: STARTER KIT SETUP (DEVICE, DEBUG MODE)

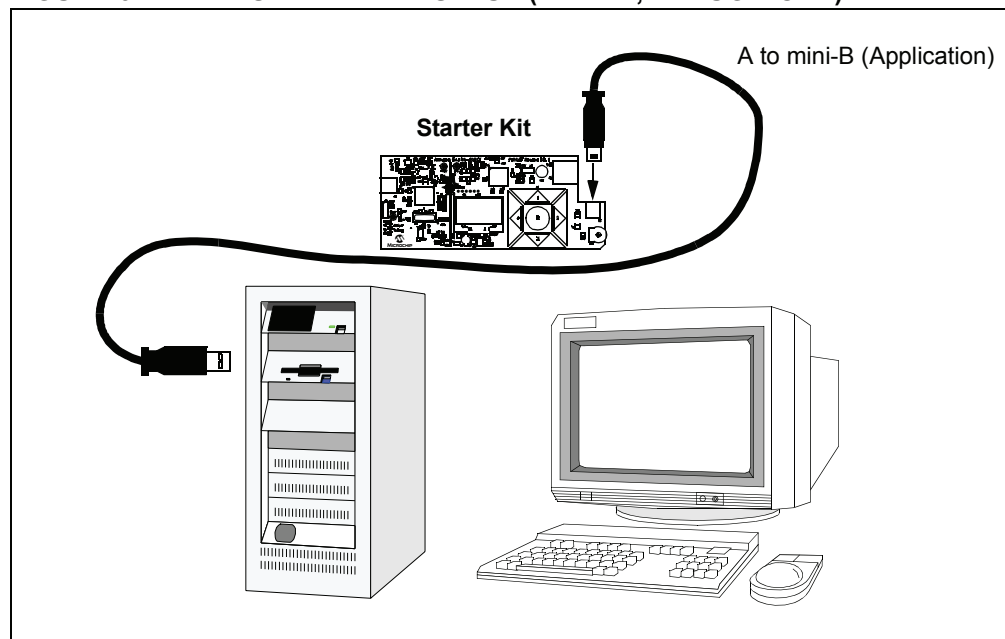

Configuring the Starter Kit Hardware

3.2.4 Embedded Host, Release Mode (Stand-Alone Mode)

In this configuration, the starter kit has been programmed with a debugged, stand-alone USB embedded host application; programmer/debugger support is not needed. Because of the absence of a host PC, this configuration can truly be considered a “stand-alone” operation.

Since there are no connections to a host PC, the starter kit board must be physically modified to accept an external power supply. A regulated power supply providing 5 VDC must be available.

Make the following modifications to the starter kit (Figure 3-3):

1. Install posts at the VBUS and GND test points on the board.
2. Populate the site for R16 (adjacent to the VBUS test point) with a 0 ohm resistor.
3. Supply +5 VDC and ground connections from the external power supply to the VBUS and GND connections on the board.

FIGURE 3-3: STARTER KIT MODIFICATIONS FOR STAND-ALONE POWER OPERATION

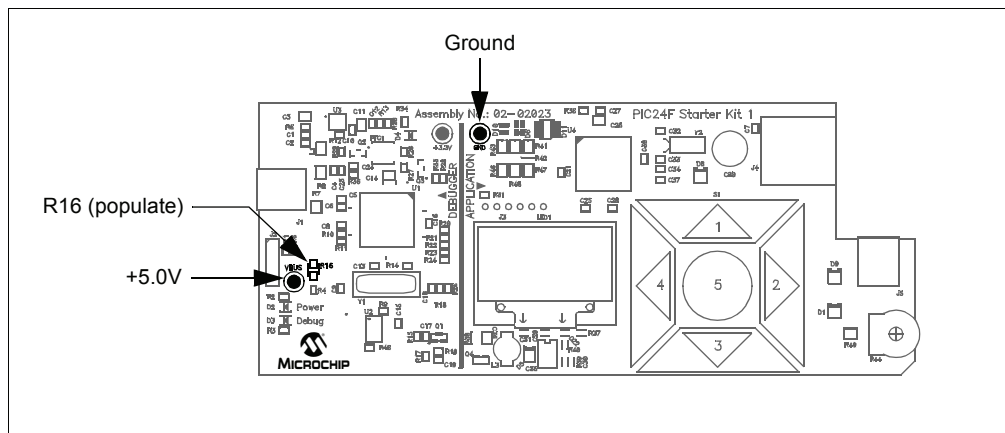

If the modifications are done correctly, and power is connected correctly, the green Target Power LED (D4) is lit. The starter kit also goes through its power-on sequence before LED1 displays the “PIC24 Starter Kit” main menu.

When configured for external power operation, the programmer/debugger function is essentially disabled. To re-enable these functions, disconnect the external power from the board and remove the resistor/jumper from R16 before connecting the USB cable to J1.

CAUTION

If you externally power VBUS via the test point, please make certain that you first disconnect any USB cables connected to a computer or hub. Otherwise, damage to the PC's USB port or the external hub may result.

MPLAB Starter Kit for PIC24F User's Guide

NOTES:

Chapter 4. Developing an Application

The MPLAB Starter Kit for PIC24F may be used with MPLAB® IDE, the free integrated development environment available on Microchip's web site. MPLAB IDE allows the starter kit to be used as an in-circuit debugger as well as a programmer for the featured device.

In-circuit debugging allows you to run, examine and modify your program for the device embedded in the starter kit hardware. This greatly assists you in debugging your firmware and hardware together.

Special starter kit software interacts with the MPLAB IDE application to run, stop and single-step through programs. Breakpoints can be set and the processor can be reset. Once the processor is stopped, the register's contents can be examined and modified.

For more information on how to use MPLAB IDE, reference the following documentation:

- MPLAB® IDE User's Guide (DS51519)
- MPLAB® IDE Quick Start Guide (DS51281)
- MPLAB® IDE On-line Help

This chapter includes the following:

- Setting Up an Example Application for Debug
- Running the Example Application
- Debugging the Example Application
- Programming the Debugged Application
- Creating Other Applications
- Determining Device Support and Reserved Resources
- Debug Version Information
- Troubleshooting

MPLAB Starter Kit for PIC24F User's Guide

4.1 SETTING UP AN EXAMPLE APPLICATION FOR DEBUG

The MPLAB IDE software that is installed on your PC by the starter kit CD-ROM automatically opens an example application that you may use to examine debug features of the starter kit. To prepare the application for debug:

1. Launch MPLAB IDE. The example application project and related workspace will open. For information on projects and workspaces, see the MPLAB IDE documentation mentioned at the beginning of this chapter.
2. Select **Project>Build All** to build the application code. The build's progress will be visible in the **Build** tab of the Output window.
3. Select **Debugger>Select Tool>Starter Kits**. MPLAB IDE will change to add starter kit debug features (Figure 4-1):
 - (1) the status bar will show Starter Kits as the debug tool
 - (2) a Starter Kit debug toolbar will be added
 - (3) the Debugger menu will change to add Starter Kit debug functions
 - (4) the Output window will display communication status between MPLAB IDE and the starter kit on the **Starter Kit Debugger** tab.

Also, several device resources are used for debug. For details, see **Section 4.6 "Determining Device Support and Reserved Resources"**.

FIGURE 4-1: STARTER KIT AS DEBUG TOOL

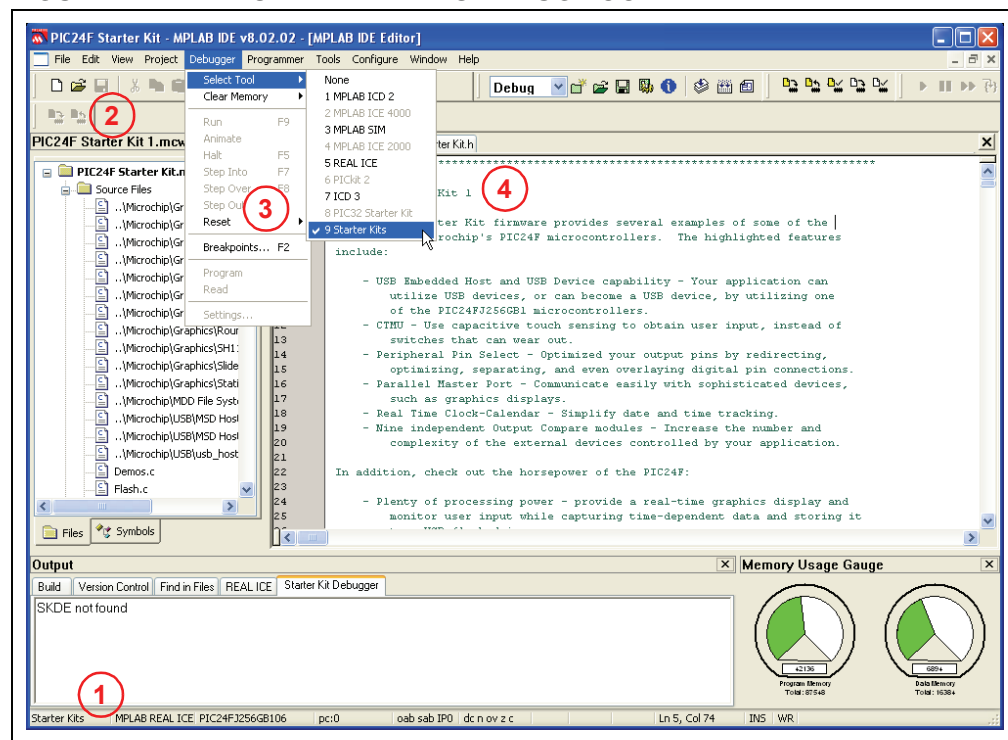







4. Select **Debugger>Program** to program the application code into the PIC24FJ256GB106 device on the starter kit. The debug programming progress will be visible in the **Starter Kit** tab of the Output window.

Note: Debug executive code is automatically programmed in the upper program memory of the starter kit device when the starter kit is selected as a debugger. Debug code must be programmed into the target device to use the in-circuit debugging capabilities of the starter kit.

4.2 RUNNING THE EXAMPLE APPLICATION

The starter kit executes in either real time (Run) or steps (Step Into, Step Over, Animate.) Real-time execution occurs when you select **Run** in MPLAB IDE. Once the device code is halted, either by **Halt** or a breakpoint, you can step.

The following toolbar buttons can be used for quick access to commonly used debug operations:

Debugger Menu	Toolbar Buttons
Run	
Halt	
Animate	
Step Into	
Step Over	
Reset	

To see how these options function, do the following:

1. Select *Debugger>Reset>Processor Reset* or click the **Reset** button to reset the program.
2. Select *Debugger>Run* or click the **Run** button. Observe how the application operates.
3. Select *Debugger>Halt* or click the **Halt** button to stop the program execution. A green solid arrow will mark the line of code in the File window where the program halted.
4. Select *Debugger>Step Into* or click the **Step Into** button to step the program execution once. The green solid arrow will move down one line of code in the File window. Click the button several times to step through some code.
5. Select *Debugger>Reset>Processor Reset*, click the **Reset** button to reset the program again. The arrow will disappear, meaning the device is reset.

4.3 DEBUGGING THE EXAMPLE APPLICATION

For the example code given, everything works fine. However, when you are developing code, it will likely not work the first time and need to be debugged. MPLAB IDE provides an editor and several debug features, such as breakpoints and Watch windows, to aid in application code debugging.

This section includes:

- Editing Application Code
- Using Breakpoints and Mouseovers
- Using Watch Windows

4.3.1 Editing Application Code

To view application code so it may be edited, do one of the following:

- Select *Edit>New* to create new code or *Edit>Open* to search for and open an existing code file.
- Double-click on a file in the Project window to open an existing code file. See an example Project window in Figure 4-2.

FIGURE 4-2: EXAMPLE PROJECT

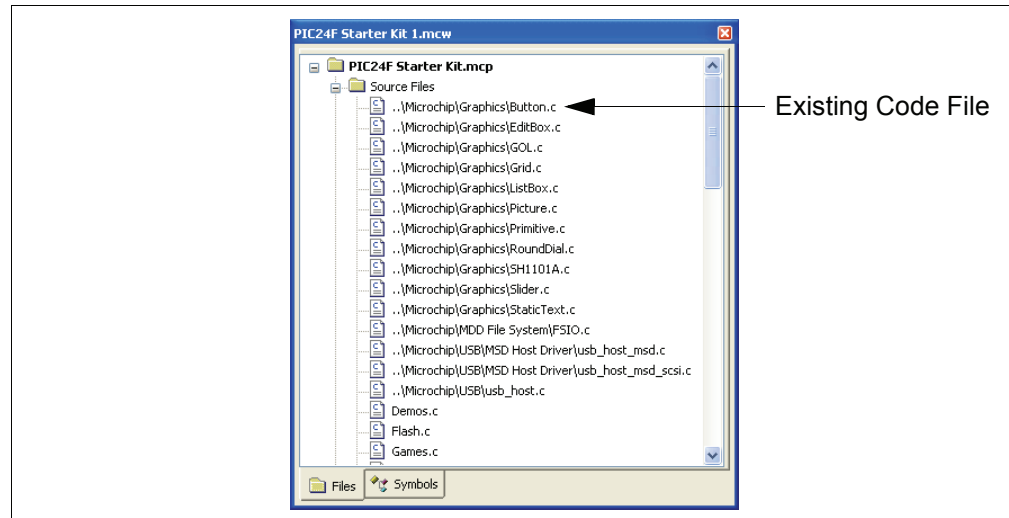

For more information on using the editor to create and edit code, see MPLAB IDE Editor Help.

4.3.2 Using Breakpoints and Mouseovers

To set a breakpoint in code, use one of the following methods:

- **Double-Click in Gutter:** Double-click in the window gutter next to the line of code where you want the breakpoint. Double-click again to remove the breakpoint.
- **Pop-up Menu:** Place the cursor over the line of code where you want the breakpoint. Then, right click to pop up a menu and select “Set Breakpoint”. Once a breakpoint is set, “Set Breakpoint” will become “Remove Breakpoint” and “Disable Breakpoint”. Other options on the pop-up menu under Breakpoints are for deleting, enabling or disabling all breakpoints.
- **Breakpoint Dialog:** Open the Breakpoint dialog (*Debugger>Breakpoints*) to set, delete, enable or disable breakpoints. See MPLAB IDE Help for more information on this dialog.

A breakpoint set in code appears as a red “stop sign” with a “B”. Once code is halted, hovering over variables pops up the current value of those variables (Figure 4-3.)

Note: This feature must be set up. From the menu bar, select *Edit>Properties*; from the **Properties** dialog, select the **Tooltips** tab, then click the checkbox for “Enable Variable Mouseover Values”.

FIGURE 4-3: EXAMPLE BREAKPOINT

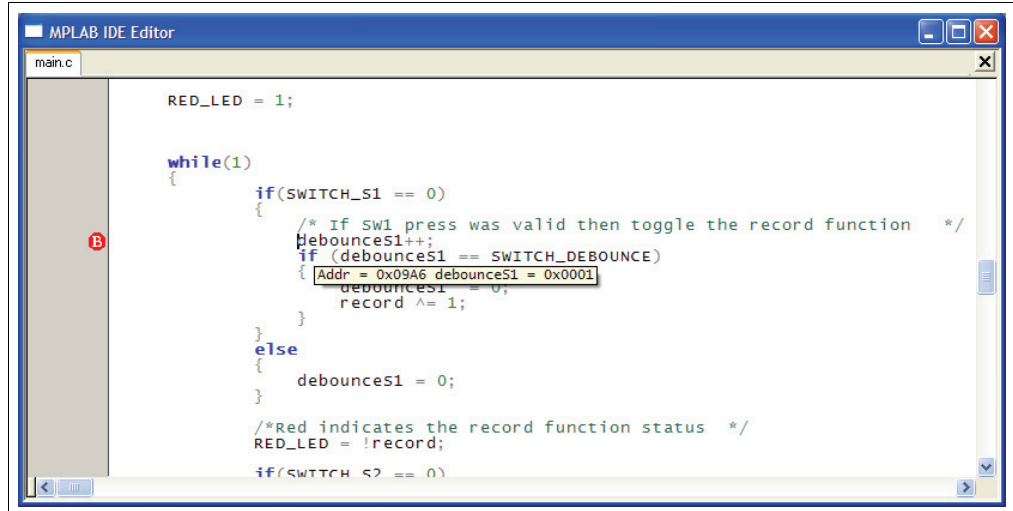

4.3.3 Using Watch Windows

To use a Watch window:

1. The Watch window is made visible on the desktop by selecting *View>Watch*. It contains four selectable watch views (via tabs) in which to view variables (SFRs, symbols and absolute addresses).
2. Select an SFR or symbol from the list and click the related **Add** button to add it to the Watch window, or click in the "Address" column and enter an absolute address.

A Watch window populated with the SFRs and Symbols will look like Figure 4-4. For more on using Watch windows, see MPLAB IDE Help.

FIGURE 4-4: EXAMPLE WATCH

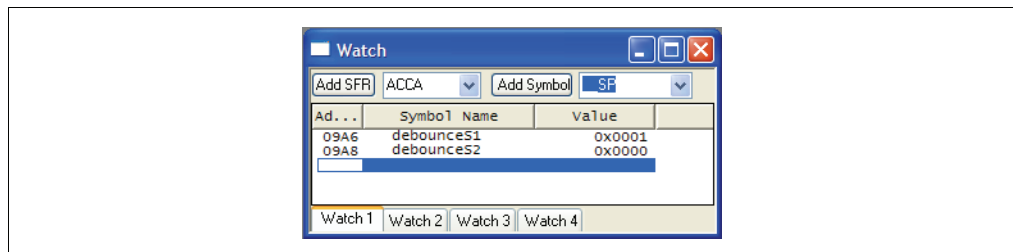

4.4 PROGRAMMING THE DEBUGGED APPLICATION

When the program is successfully debugged and running, the next step is to program the device for stand-alone operation in the finished design. When doing this, the resources reserved for debug are released for use by the application. To program the application, use the following steps:

1. Disable starter kits as a debug tool by selecting *Debugger>Select Tool>None*.
2. Select starter kits as the programmer in the *Programmer>Select Programmer* menu.
3. Select *Programmer>Program*.

Now the starter kit will run independently.

4.5 CREATING OTHER APPLICATIONS

This starter kit is just one way to use Microchip PIC24F microcontrollers in an application. Other tools and resources exist to support these devices.

- PIC24 Demo Boards: Several boards, such as the Explorer 16 Starter Kit, are available for developing applications.
- MPLAB C30 C Compiler, Full Version: More optimization options than the student version for full-scale development.
- Application Notes: Libraries and example applications with source code for using the PIC24F family of microcontrollers.

For more information on demo boards on application notes, see the design center at the Microchip web site (www.microchip.com). For additional information on the full version of the MPLAB C30 Compiler, go to <http://www.microchip.com/c30>.

4.6 DETERMINING DEVICE SUPPORT AND RESERVED RESOURCES

Due to the built-in in-circuit debugging capability of ICD devices and the In-Circuit Serial Programming™ (ICSP™) function offered by the debugger, the starter kit uses some on-chip resources when debugging. It also uses program memory and file register locations in the target device during debugging. These locations are not available for use by user code. In the MPLAB IDE, registers marked with an “R” in register displays represent reserved registers.

For information on device resources that are needed for in-circuit debugging, please refer to the MPLAB ICD 2 Help, found in the MPLAB IDE under *Help>Topics*. The device reserved resource information found under “Resources Used By MPLAB ICD 2” is the same for the starter kit.

4.7 DEBUG VERSION INFORMATION

Selecting either *Debugger>Settings* or *Programmer Settings* from the menu bar opens the Starter Kit Settings dialog. Currently, there is only one (**Info**) tab on this dialog, displaying the following information:

- Firmware Version: The version of firmware on the starter kit board.
- Debug Exec Version: The version of the debug executive that is loaded into the PIC24F device program memory to enable debug operation.

4.8 TROUBLESHOOTING

Debug Connection Problems

While using the starter kit as a debugger, you may get the error “Unable to Enter Debug Mode” when programming the device. This can result from communication being lost between the starter kit and MPLAB IDE. To resolve this:

1. Unplug the USB cable from the starter kit.
2. Plug the USB cable back into the starter kit.

MPLAB IDE should automatically reconnect to the starter kit. If this does not work, do the following:

1. Check the USB connection between the PC and starter kit at both ends.
2. If using a USB hub, make sure it is powered.
3. Make sure the USB port is not in use by another device.

Programming Problems

- If during the course of developing your own application you can no longer program the device on the starter kit, you may have set device Configuration bits to code-protect or some other state that prevents programming. To view the settings of the Configuration bits, select Configure>Configuration Bits.

MPLAB Starter Kit for PIC24F User's Guide

NOTES:

Chapter 5. Hardware

This chapter provides a functional overview of the MPLAB Starter Kit for PIC24F, and identifies the major hardware components. Topics covered include:

- Application Functional Overview
- Programmer/Debugger Functional Overview
- Board Components

5.1 APPLICATION FUNCTIONAL OVERVIEW

Figure 5-1 illustrates the main functions of the starter kit:

FIGURE 5-1: APPLICATION SIDE BLOCK DIAGRAM

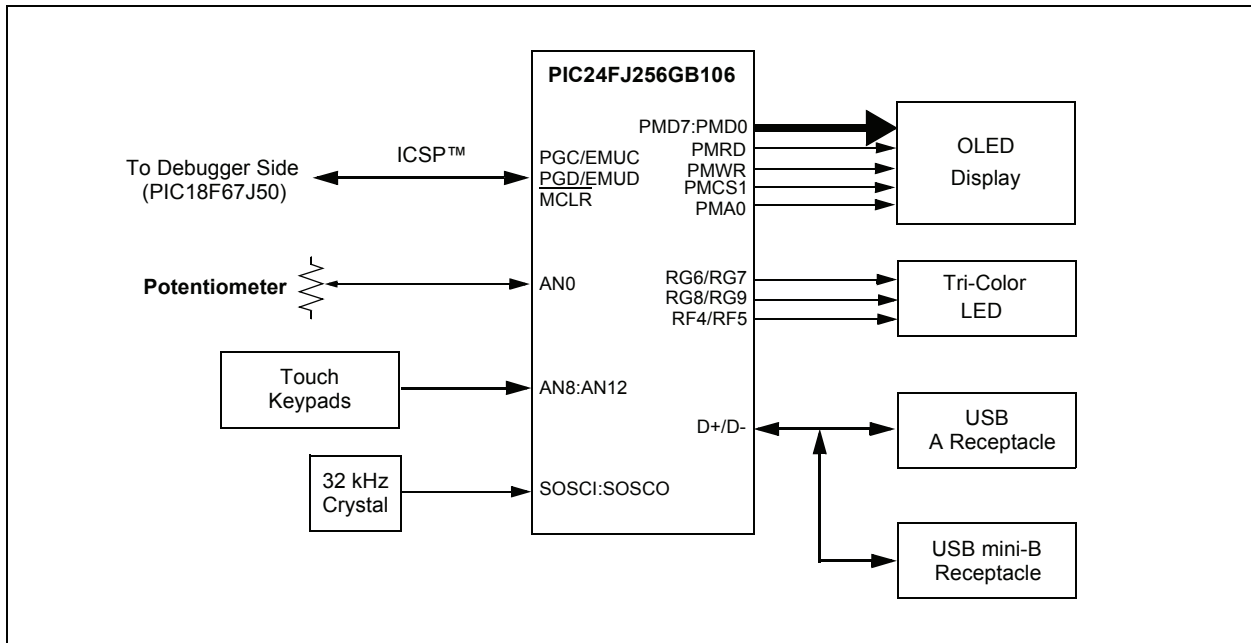

The application side of the starter kit is centered on the PIC24F256GB106 microcontroller, which requires very little additional hardware to perform its tasks. All application code is stored in the device's Flash program memory. In addition to the application core, the preloaded demo uses substantial parts of the Microchip USB Stack Library, the Microchip Memory Disk Drive File System and the Microchip Graphics Library to function.

The application accepts user inputs from the capacitive touch pad (S1) and the potentiometer (R44). The microcontroller uses one of its A/D converter channels to sample and convert the potentiometer's value to a digital value for the Data Graphing and Data Capture demos. Five additional A/D channels are used to monitor the individual touch pads of S1. The values from these channels are analyzed with the CTMU to determine when a touch-and-release event occurs on any of the pads. The application firmware determines which action to take based on the application's current context.

MPLAB Starter Kit for PIC24F User's Guide

The microcontroller directly drives the OLED display (LED1) and the tri-color LED (D6, D10 or D11, depending on the board's manufacturing option). The microcontroller uses the Parallel Master Port to drive the OLED through the PMD7:PMD0 data lines, while PMA0, PMCS2, PMRD and PMWR serve as control signals. A DC boost circuit comprised of power MOSFET Q4, along with D5 and L3, provides the operating voltage for the OLED.

The individual channels of the tri-color LED are driven directly by three of the microcontroller's PWM modules, assigned to outputs on pins RF4/RF5, RG6/RG7 and RG8/RG9. Two output pins are used for each PWM to ensure sufficient drive strength for each LED component.

The microcontroller uses an on-chip USB On-The-Go (OTG) engine and transceiver to communicate with USB A and mini-B receptacles on the application side. While both receptacles are populated, only the A receptacle is used in this version of the demo application. The mini-B receptacle is available for users who may wish to design a peripheral application.

5.2 PROGRAMMER/DEBUGGER FUNCTIONAL OVERVIEW

Figure 5-2 illustrates the debugging/programming operation of the starter kit.

FIGURE 5-2: STARTER KIT PROGRAMMER/DEBUGGER BLOCK DIAGRAM

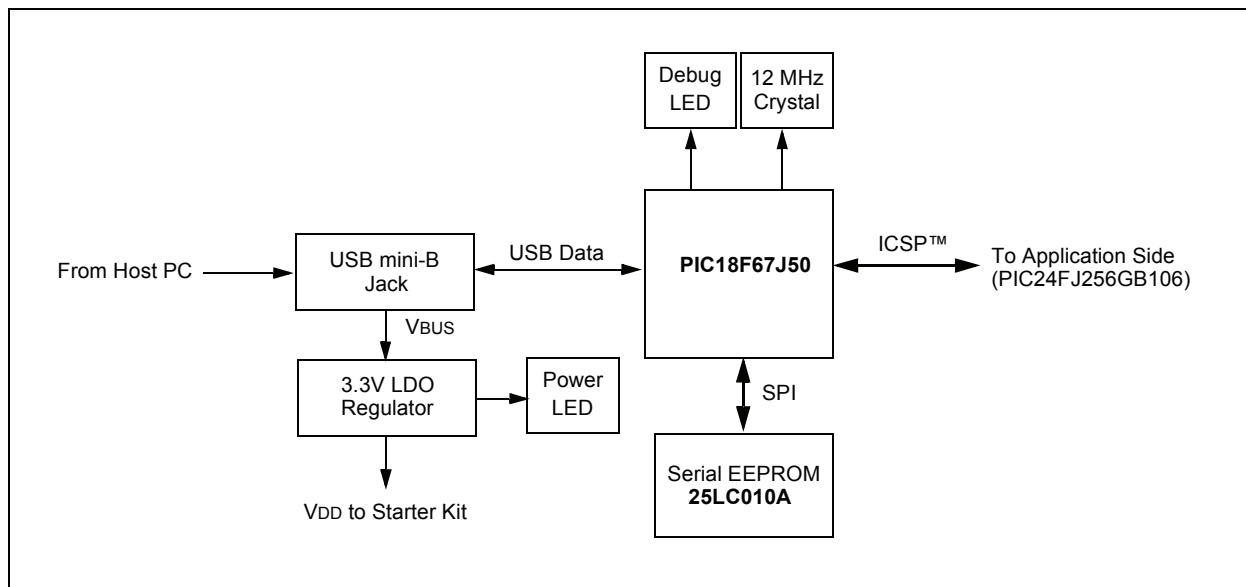

In its default configuration, the Starter Kit functions as a USB bus-powered device. Power is provided via the USB cable; the nominal 5 volt unregulated supply is regulated by a Microchip MC1727 3.3 volt low-dropout (LDO) linear regulator. Proper main system power is indicated by the green LED (D2).

The debugging and programming side of the Starter Kit is controlled by a PIC18F67J50 microcontroller running at 48 MHz. The PIC18F67J50's built-in USB engine provides the communications interface between the Starter Kit and the host PC. The microcontroller manages debugging or programming of the target PIC24FJ256GB106 by controlling the target's MCLR, PGC1/EMUC1, and PGD1/EMUD1 signals. Target power is switched on and off via a low VCE saturation PNP transistor (Q1) configured as a high-side switch. Target clocking is also provided by the PIC18F67J50.

A Microchip 25LC010A serial EEPROM is used to store the starter kit's serial number and debug control information.

5.3 BOARD COMPONENTS

Figure 5-3 identifies the key hardware components for the starter kit.

FIGURE 5-3: PIC24F STARTER KIT COMPONENT LAYOUT

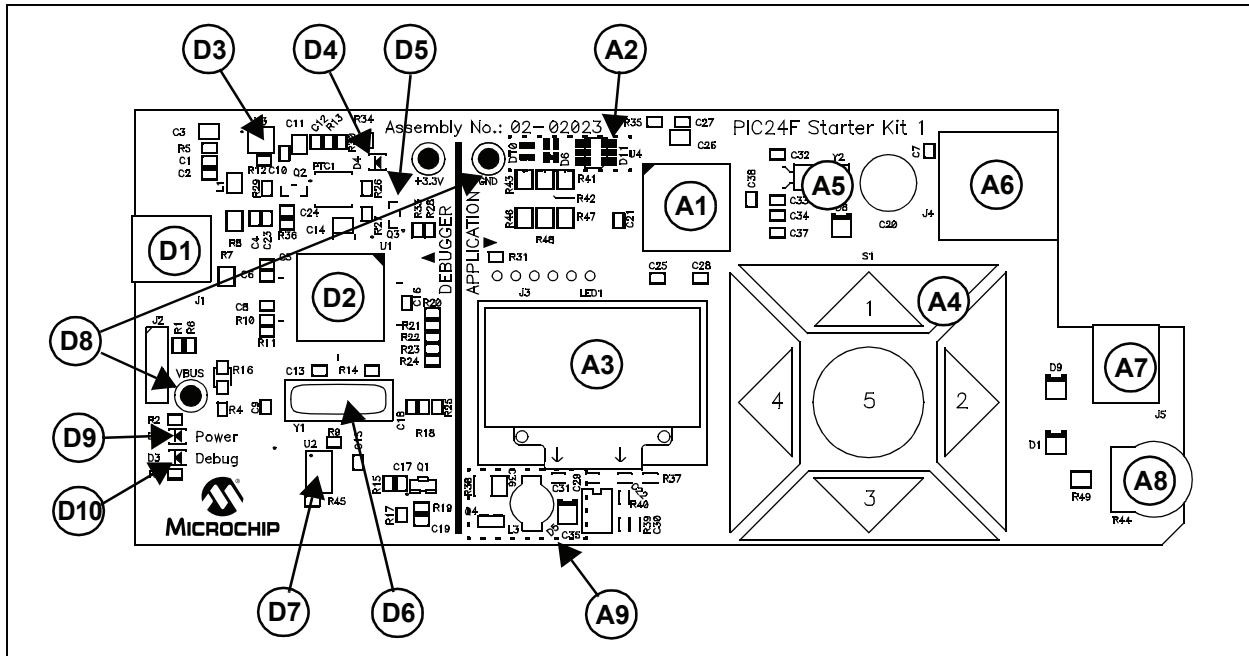

TABLE 5-1: PIC24F STARTER KIT COMPONENT DESCRIPTIONS

Ref	Debugger/Programmer Component	Ref	Application Component
D1	mini-B USB Receptacle (J1)	A1	PIC24F256GB106 Microcontroller (U6)
D2	PIC18F67J50 Microcontroller (U2)	A2	Tri-Color LED Pads (D6, D10 or D11)
D3	MCP1727 Voltage Regulator (U1)	A3	OLED Display (LED1)
D4	Target Power LED (D4)	A4	Capacitive Touch Pad (S1)
D5	Low VCE Saturation PNP Transistor Switch (Q1)	A5	32.768 kHz (RTCC) Crystal (Y2)
D6	Debugger/Programmer Clock Crystal (Y1)	A6	USB A (Embedded Host) Receptacle (J4)
D7	25LC010A Serial EEPROM (U3)	A7	mini-B USB (Peripheral) Receptacle (J5)
D8	VBUS and GND Test Points	A8	Potentiometer (R44)
D9	System Power LED (D2)	A9	OLED Voltage Boost Circuitry
D10	Debug LED (D3)		

5.3.1 Programmer/Debugger Components

The components listed here (in order of their reference tags in Figure 5-3) are the key components of the programmer/debugger side of the starter kit:

- D1. **mini-B USB Receptacle (J1):** Provides system power and bidirectional communication between the host PC and starter kit.
- D2. **PIC18F67J50 Microcontroller (U2):** Controls the programming/debugging operations of the target PIC24FJ256GB106 microcontroller. It also provides the 12 MHz clock for the PIC24F microcontroller.
- D3. **MCP1727 Voltage Regulator (U1):** The 3.3V linear regulator regulates the USB unregulated voltage to 3.3 volts (with respect to VSS) and supplies the starter kit with system power.
- D4. **Target Power LED (D4):** When lit, indicates that power is being supplied to the application side of the starter kit from VBUS (either from a USB connection or from the VBUS test point).

- D5. **Low VCE Saturation PNP Transistor Switch (Q1):** Provides target power (via high-side switching) to the application side components via control by the PIC18F67J50.
- D6. **Debugger/Programmer Clock Crystal (Y1):** Provides an accurate 12 MHz frequency reference for the PIC18F67J50 microcontroller for stable USB operations in Programming and Debugging modes. The PIC18F67J50 also uses this to generate a second 12 MHz clock for use by the PIC24FJ256GB106 microcontroller.
- D7. **25LC010A Serial EEPROM (U3):** Provides nonvolatile parameter storage for the PIC18F67J50.
- D8. **Vbus and GND Test Points:** These unpopulated pads may be equipped with appropriate connectors and furnished with power to operate the board in Stand-Alone mode.
- D9. **System Power LED (D2):** When lit, indicates that the starter kit is powered via the USB.
- D10. **Debug LED (D3):** When lit, indicates that communication between the starter kit and MPLAB IDE has been successfully established.

5.3.2 Application Components

The components listed here (in order of their reference tags in Figure 5-3) are the key components of the application side of the starter kit:

- A1. **PIC24F256GB106 Microcontroller (U6):** This provides the processing power for the demo applications and application development on the starter kit. The microcontroller features 256 Kbytes of Flash program memory and 16 Kbytes RAM. The demo application uses an external 12 MHz signal from the programmer side as clock source. Custom applications that do not use the USB module may also use the microcontroller's on-chip FRC oscillator as a clock source. (USB applications must use the 12 MHz programmer clock source, as the tolerance of the FRC oscillator exceeds USB specifications.)
- A2. **Tri-Color LED Pads (D6, D10 or D11):** One of these locations is populated with a three-channel (RGB) LED; the choice of the populated site depends on the availability of components at the time of the board's assembly. Functionally, the LEDs at any of these sites are interchangeable.
- A3. **OLED Display (LED1):** A 128 x 64 pixel, monochrome organic LED array provides a wide range of graphics and alphanumeric display options.
- A4. **Capacitive Touch Pad (S1):** This 5-element keypad is an integral part of the board's top layer. The application responds to capacitive changes induced by direct contact with the user by monitoring each of the touch pad's elements with the microcontroller's integrated CTMU module.
- A5. **RTCC Crystal (Y2):** Provides an accurate 32.768 kHz reference for the microcontroller's secondary oscillator. This is used in turn as the time base for the on-chip Real-Time Clock (RTC).
- A6. **USB A Receptacle (J4):** The application uses this receptacle to connect with USB peripherals while operating as an embedded host.
- A7. **Mini-B USB Receptacle (J5):** Physically identical to J1, this provides USB connectivity for the application side when it is functioning as a peripheral device.
- A8. **Potentiometer (R44):** Provides an analog input to the microcontroller for certain demo applications.
- A9. **OLED Voltage Boost Circuitry:** L3, D5 and Q4 (along with other passive components) are connected in a voltage boost topology. This provides the OLED display with its nominal operating voltage of 13 Vdc.

Appendix A. Starter Kit Schematics

The following schematic diagrams are included in this appendix:

Programmer/Debugger:

- Figure A-1: Programmer/Debugger Control System and EEPROM
- Figure A-2: Programmer/Debugger USB Interface, Target Power Switching and Regulation

Application:

- Figure A-3: Application Microcontroller, Touch Switches and Associated Components
- Figure A-4: OLED Display, LED and Application Side USB Connectors

MPLAB Starter Kit for PIC24F User's Guide

FIGURE A-1: STARTER KIT SCHEMATIC, SHEET 1: PROGRAMMER/DEBUGGER CONTROL SYSTEM AND EEPROM

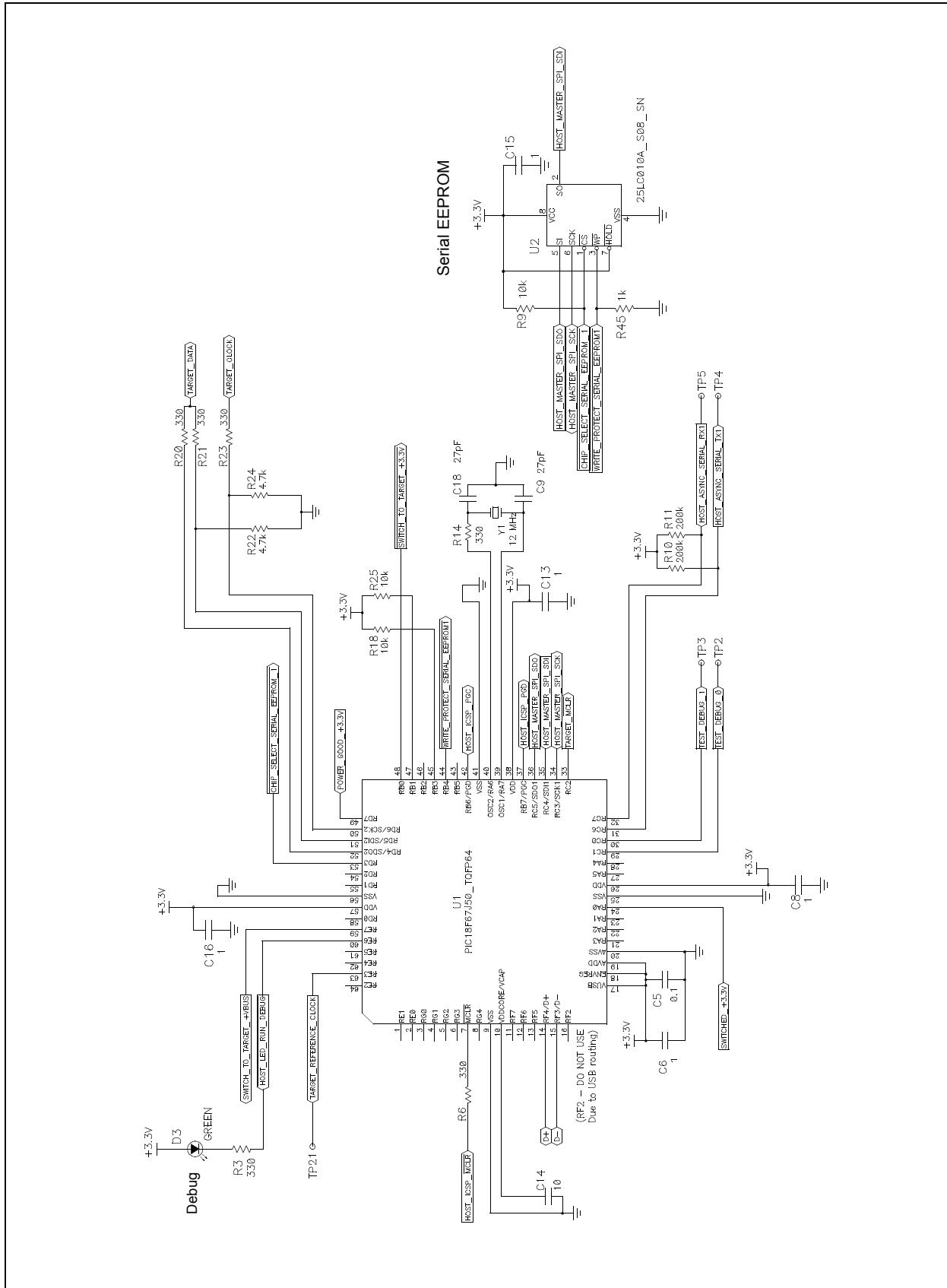

MPLAB Starter Kit for PIC24F User's Guide

FIGURE A-3: STARTER KIT SCHEMATIC, SHEET 3: APPLICATION MICROCONTROLLER, TOUCH SWITCHES AND ASSOCIATED COMPONENTS

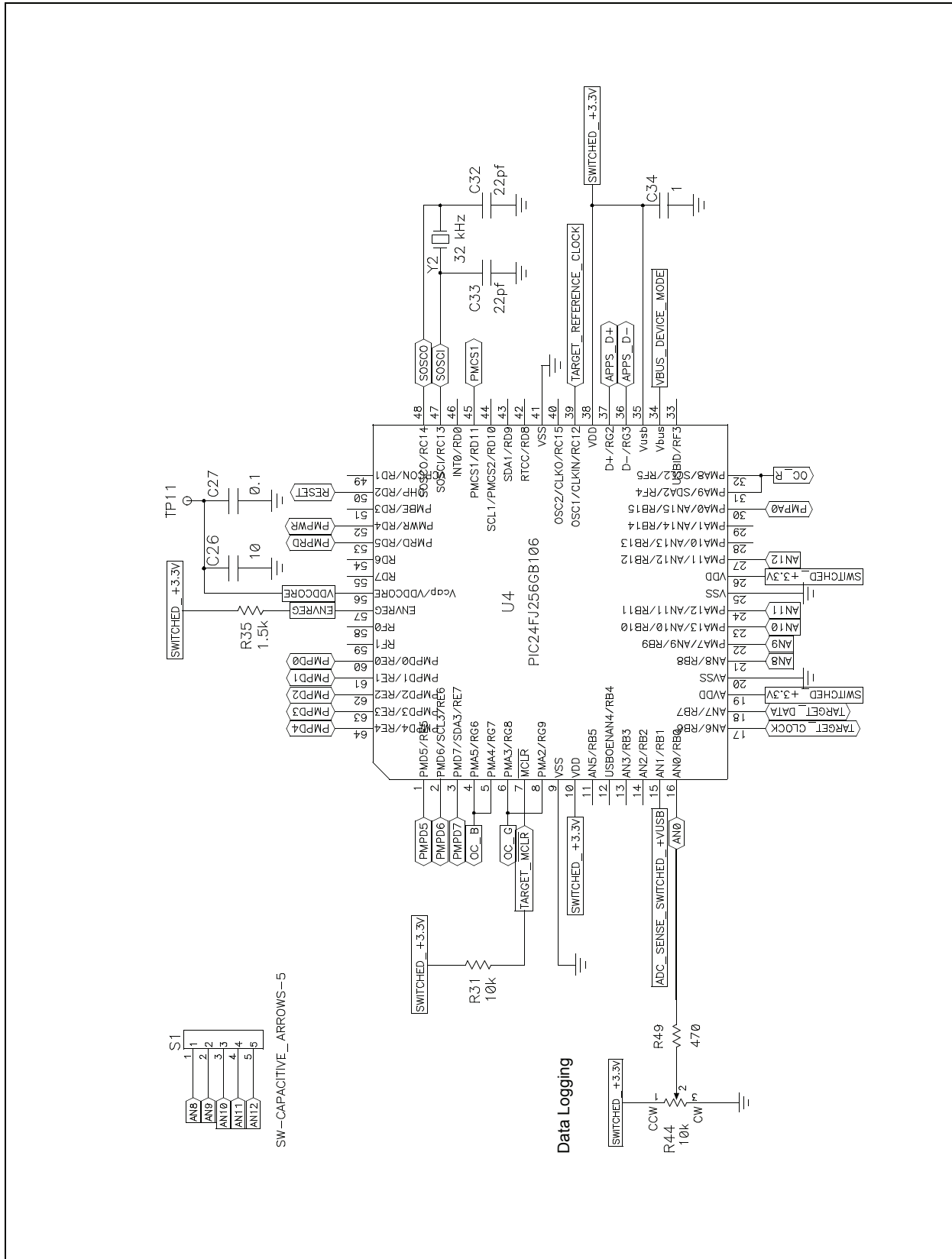
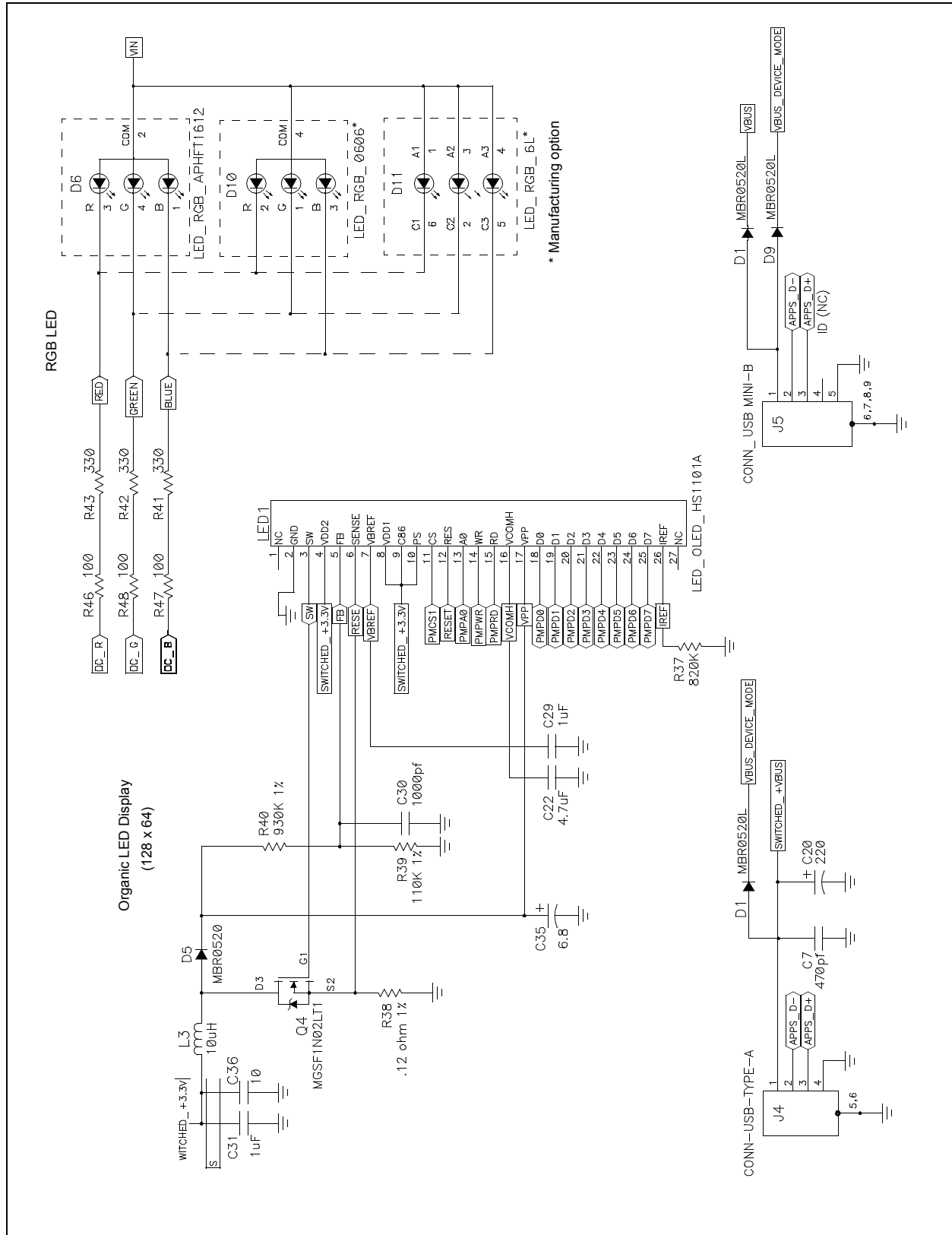

FIGURE A-4: STARTER KIT SCHEMATIC, SHEET 4: OLED DISPLAY, LED AND APPLICATION SIDE USB CONNECTORS



MPLAB Starter Kit for PIC24F User's Guide

NOTES:

Index

B		E	
Block Diagrams		Embedded Host, Debug Mode.....	15
Starter Kit		Embedded Host, Release Mode	17
Application Side	27	H	
Programmer/Debugger Side.....	28	Halt.....	21
Board Components		Host Computer Requirements.....	7
Capacitive Touch Pad.....	30	I	
Debug LED	30	Initial Board Setup.....	8
Debugger/Programmer Clock Crystal	30	Internet Address.....	4
mini-B USB Connector.....	29, 30	M	
OLED Display	30	Microchip Internet Web Site	4
OLED Voltage Boost Circuitry	30	MPLAB IDE	7, 19
PIC18F67J50.....	29	P	
PIC24F256GB110 Microcontroller.....	30	Power Options.....	15
PNP Transistor Switch.....	30	Programmer	24
Potentiometer	30	R	
RTCC Crystal.....	30	Reading, Recommended	3
Serial EEPROM	30	Real-Time Clock and Calendar (RTCC).....	11
Target Power LED	29	Reserved Resources.....	24
Tri-Color LED.....	30	Reset.....	21
USB A Receptacle	30	Run.....	21
Vbus and GND Test Points.....	30, 29	S	
Breakpoints	21	Schematic Diagrams	31
C		Stand-Alone Mode	17
Charge Time Measurement Unit (CTMU)	10	Starter Kit	
Configuration Bits.....	25	Board Components	29
Customer Notification Service.....	4	Step.....	21
Customer Support.....	5	T	
D		Troubleshooting	25
Debug	7	U	
Executive	20	Unable to Enter Debug Mode.....	25
Reserved Resources	24	W	
Setup	20	Warranty Registration	2
Demonstration Applications	9	Watch Window	21
Interactive Display System	9	WWW Address.....	4
Other Interactive Demos	13		
Real-Time Data Capture	13		
Real-Time Data Graphing.....	12		
RGB LED Control	11		
Time and Date	11		
Touch Interface	10		
Calibration	10		
USB Flash Drive Interface	12		
Device, Debug Mode	15		
Device, Release Mode.....	16		
Documentation			
Conventions.....	2		
Layout.....	1		



WORLDWIDE SALES AND SERVICE

AMERICAS

Corporate Office
2355 West Chandler Blvd.
Chandler, AZ 85224-6199
Tel: 480-792-7200
Fax: 480-792-7277
Technical Support:
<http://support.microchip.com>
Web Address:
www.microchip.com

Atlanta

Duluth, GA
Tel: 678-957-9614
Fax: 678-957-1455

Boston

Westborough, MA
Tel: 774-760-0087
Fax: 774-760-0088

Chicago

Itasca, IL
Tel: 630-285-0071
Fax: 630-285-0075

Dallas

Addison, TX
Tel: 972-818-7423
Fax: 972-818-2924

Detroit

Farmington Hills, MI
Tel: 248-538-2250
Fax: 248-538-2260

Kokomo

Kokomo, IN
Tel: 765-864-8360
Fax: 765-864-8387

Los Angeles

Mission Viejo, CA
Tel: 949-462-9523
Fax: 949-462-9608

Santa Clara

Santa Clara, CA
Tel: 408-961-6444
Fax: 408-961-6445

Toronto

Mississauga, Ontario,
Canada
Tel: 905-673-0699
Fax: 905-673-6509

ASIA/PACIFIC

Asia Pacific Office
Suites 3707-14, 37th Floor
Tower 6, The Gateway
Harbour City, Kowloon
Hong Kong
Tel: 852-2401-1200
Fax: 852-2401-3431

Australia - Sydney
Tel: 61-2-9868-6733
Fax: 61-2-9868-6755

China - Beijing
Tel: 86-10-8528-2100
Fax: 86-10-8528-2104

China - Chengdu
Tel: 86-28-8665-5511
Fax: 86-28-8665-7889

China - Hong Kong SAR
Tel: 852-2401-1200
Fax: 852-2401-3431

China - Nanjing
Tel: 86-25-8473-2460
Fax: 86-25-8473-2470

China - Qingdao
Tel: 86-532-8502-7355
Fax: 86-532-8502-7205

China - Shanghai
Tel: 86-21-5407-5533
Fax: 86-21-5407-5066

China - Shenyang
Tel: 86-24-2334-2829
Fax: 86-24-2334-2393

China - Shenzhen
Tel: 86-755-8203-2660
Fax: 86-755-8203-1760

China - Wuhan
Tel: 86-27-5980-5300
Fax: 86-27-5980-5118

China - Xiamen
Tel: 86-592-2388138
Fax: 86-592-2388130

China - Xian
Tel: 86-29-8833-7252
Fax: 86-29-8833-7256

China - Zhuhai
Tel: 86-756-3210040
Fax: 86-756-3210049

ASIA/PACIFIC

India - Bangalore
Tel: 91-80-4182-8400
Fax: 91-80-4182-8422

India - New Delhi
Tel: 91-11-4160-8631
Fax: 91-11-4160-8632

India - Pune
Tel: 91-20-2566-1512
Fax: 91-20-2566-1513

Japan - Yokohama
Tel: 81-45-471- 6166
Fax: 81-45-471-6122

Korea - Daegu
Tel: 82-53-744-4301
Fax: 82-53-744-4302

Korea - Seoul
Tel: 82-2-554-7200
Fax: 82-2-558-5932 or
82-2-558-5934

Malaysia - Kuala Lumpur
Tel: 60-3-6201-9857
Fax: 60-3-6201-9859

Malaysia - Penang
Tel: 60-4-227-8870
Fax: 60-4-227-4068

Philippines - Manila
Tel: 63-2-634-9065
Fax: 63-2-634-9069

Singapore
Tel: 65-6334-8870
Fax: 65-6334-8850

Taiwan - Hsin Chu
Tel: 886-3-572-9526
Fax: 886-3-572-6459

Taiwan - Kaohsiung
Tel: 886-7-536-4818
Fax: 886-7-536-4803

Taiwan - Taipei
Tel: 886-2-2500-6610
Fax: 886-2-2508-0102

Thailand - Bangkok
Tel: 66-2-694-1351
Fax: 66-2-694-1350

EUROPE

Austria - Wels
Tel: 43-7242-2244-39
Fax: 43-7242-2244-393

Denmark - Copenhagen
Tel: 45-4450-2828
Fax: 45-4485-2829

France - Paris
Tel: 33-1-69-53-63-20
Fax: 33-1-69-30-90-79

Germany - Munich
Tel: 49-89-627-144-0
Fax: 49-89-627-144-44

Italy - Milan
Tel: 39-0331-742611
Fax: 39-0331-466781

Netherlands - Drunen
Tel: 31-416-690399
Fax: 31-416-690340

Spain - Madrid
Tel: 34-91-708-08-90
Fax: 34-91-708-08-91

UK - Wokingham
Tel: 44-118-921-5869
Fax: 44-118-921-5820