

## Introduction

The Advanced Configuration and Power Interface specification (ACPI; [1]), written by a consortium representing Intel, Microsoft and Toshiba, attempts to evolve the current collection of power management methods and configuration interfaces into a well-specified and unified power management and configuration mechanism. The key objective in the ACPI specification is to transfer all control of power management and configuration functions to the operating system, thus enabling Operating System Directed Power Management (OSPM). ACPI-compliant systems will benefit from a robust interface for configuring motherboard devices, a versatile power management interface enabling a wide variety of solutions with full operating-system support, and not lastly, a realm of new, intelligent possibilities added to the already broad span of PC uses.

The HIP6500B/02B ICs are to be used in conjunction with a second integrated circuit to provide a complete ACPI-sanctioned motherboard power regulation solution. The HIP6500B/HIP6020 and HIP6502B/HIP6020 chip sets (HIP6021 can substitute HIP6020 in either chip set) produce the processor core, GTL bus, memory controller hub, and AGP 4x voltages, as well as the 3.3V standby, 2.5V clock, SDRAM/RDRAM memory (or both, simultaneously), 3.3V and 5V dual voltage planes necessary for a complete PIII-Camino (or equivalent) system implementation. [2, 3, 5, 6]

## Quick Start Evaluation

### Important!

Given the specialized nature of the HIP6500B and HIP6502B, the HIP6500B/02BEVAL1 boards are meant to be evaluated only with an ATX power supply. Furthermore, only an ACPI-ready ATX supply can be used to power-up the evaluation boards (720mA capability on 5VSB output; ATX Specification v2.02, [4]). Standard laboratory power supplies are not suitable for powering up this evaluation board.

### Circuit Setup

#### %% Set Up JP1, JP2, and JP3

Before connecting the input ATX supply to the HIP6500B/02BEVAL1 board, consult the circuit schematic and data sheets and set the JP1 and JP2 configuration jumpers on the HIP6500BEVAL1, and JP2 and JP3 jumpers on the HIP6502BEVAL1 according to the configuration you wish to emulate. These particular configurations are latched in during certain times, but can be subsequently changed at certain times. See HIP6500B/02B data sheets for information on the available configurations and how to set them.

#### %% Connect the Input Power Supply

Ensuring that the supply is not plugged into the mains, or that the AC switch is off (if provided), connect the main ATX output connector to J1.

#### %% Connect the Output Loads

Connect typical standby loads to all the evaluation board's outputs. Consult Table 1 for maximum loads supported by the design of the HIP6500B/02BEVAL1 in the configuration received; consult the 'HIP6500B/02BEVAL1 Modifications' chapter for information on modifying the evaluation board to meet your special needs.

#### %% Set Start-Up State (Active Is Recommended)

If start-up in active state (S0/S1/S2) is desired, ensure both 'S3' (SW2) and 'S5' (SW3) switches are in the off position (away from 'S3' or 'S5' marking). Ensure the 'ATX ON' switch is also in the off position.

Set either the 'S3' or the 'S5' standby switch for start-up in either of the standby states. IMPORTANT: only one switch needs to be actuated, so select the standby state by turning on the switch with that name - the signal conditioning circuitry ensures correct  $\overline{S3}$  and  $\overline{S5}$  pin stimulation.

## Operation

#### %% Provide Bias Voltage to the Board

Plug the ATX supply into the mains. If the supply has an AC switch, turn it on. The '5VSB' (LP4) LED should light up, indicating the presence of 5V standby voltage on board.

#### %% Examine Start-Up Waveforms

Sleep state start-up is immediate following application of bias voltage. Using an oscilloscope or other laboratory equipment, you may study the ramp-up and/or regulation of the controlled voltages, according to the specific JP1/JP2, or JP2/JP3 configuration previously set and the specific standby state selected.

For start-up into an active state (standby switches set off prior to application of bias voltage), flip on the 'ATX ON' switch (SW1). This will turn on the main ATX outputs and the HIP6500B/02B will start up into active state. Once turned on, SW1 needs not be turned off until bias is removed from the board.

#### %% Examine Output Quality Under Varying Loads

In either state (sleep or active) vary the output loads to simulate computer loads typical of the specific operating state the circuit is in.

## Examine State Transitions

For subsequent transitions into standby states, leave the main ATX outputs enabled (SW1 on); the circuit will automatically turn them off when entering a standby state. To enter a standby state, turn on the respective switch. The 'S3' LED will light up to indicate S3 standby state, while S5 state will illuminate both 'S3' and 'S5' LEDs. However, the HIP6500B/02B will ignore any illegal transition requests, such as from S3 state to S5 state or vice versa, as shown in Figure 1.

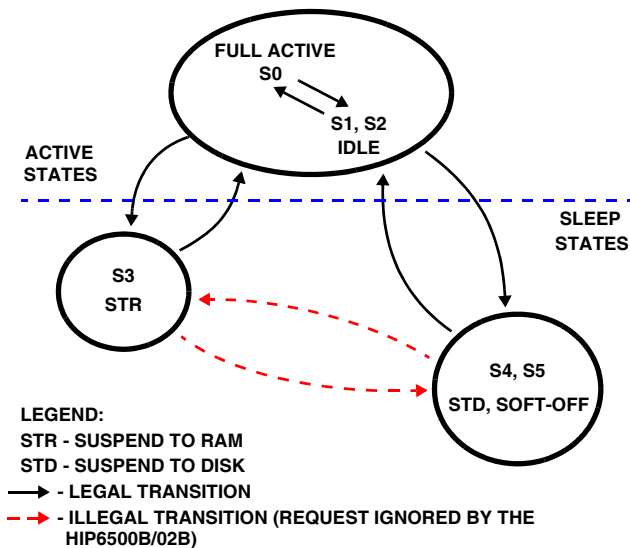

**FIGURE 1. HIP6500B/02B LEGAL/ILLEGAL STATE TRANSITIONS**

## Fault Handling

In case of a fault condition (input or output under-voltage - such as a suddenly shorted output or a loss of an input power rail), the FAULT pin asserts a logic 'high', shutting down the ATX supply's main outputs. To recover from such a shutdown, press the 'SHUTDOWN/CLEAR FAULT' button (PB1). Depressing PB1 will reset the IC and initiate a soft-start sequence, thus clearing the FAULT, and enabling the main ATX outputs.

If jumper JP3/1 (respectively, JP3 on the 6500 and JP1 on the 6502 evaluation board) "FAULT LATCH" is removed, the FAULT output will not latch the circuit. The circuit appears to latch off because the FAULT signal shuts down the ATX supply, cutting off the input supply to the faulting output, and thus keeping it from ever recovering from the fault condition. *However, it is not recommended to test the circuit against output under-voltages (output short-circuits) with the fault latch jumper removed.* Due to the very slow response of the ATX supply in response to a shutdown request, the external N/P-MOS switches (Q4, Q5, Q6, and Q7) in use at the time of testing could fail as a result of sustained over-current through the drain-source junction and bond wires. The FAULT latch circuit acts on the SS pin directly, shutting

down the IC quickly. To protect the external switches it is strongly recommended that JP3/1 FAULT LATCH jumper is shunted throughout the operation of the board.

## Configuring Sleep State Support

Sleep state support on the 3.3V<sub>DUAL</sub> and 5V<sub>DUAL</sub> outputs of the HIP6500BEVAL1 are user-configurable through jumpers JP1 and JP2. Sleep state support on the 2.5V<sub>MEM</sub>, 3.3V<sub>MEM</sub>, and 5V<sub>DUAL</sub> outputs of the HIP6502BEVAL1 are user-configurable through jumpers JP2 and JP3 (consult data sheets for sleep support details). The configurations can be changed prior to 5VSB application, during active state operation (additionally, during S4/S5 operation for HIP6502B's memory selection), as well as during chip shutdown (PB1 pressed). During all other times, the configurations are internally latched and any changes in the MSEL, EN3V<sub>DL</sub> and EN5V<sub>DL</sub> pins' logic status are ignored.

## HIP6500B/02BEVAL1 Reference Design

### General

Both evaluation boards are built on 2-ounce, 4-layer, printed circuit board (see last six pages of this application note for layout plots). Most of the components specific to the evaluation board alone, which are not needed in a real computer application, are placed on the bottom side of the board. Assuming the input supplies and the controlled output planes have their own on-board filtering (capacitors), the only components required to implement this ACPI 5-voltage controller/regulator solution are contained within the white rectangle surrounding the HIP6500B/02B on the top side of the board. All the additional circuitry contained on board has the role of duplicating the computer environment the chip would operate in. Since this additional circuitry would clutter and detract from the readability of the schematic, most of it was grouped in two blocks, named "SIGNAL CONDITIONING" and "FAULT LATCH" (see evaluation board schematics).

The boards also contain a serpentine resistor which occupies about 1/3 of both top and bottom sides of the board. The ATX supply requires some minimum loading on the +5V output in order to stay active; lack of this minimum loading causes the ATX to shut down all its outputs, except +5VSB. This minimum load is specified as 1A, but most supplies will stay active with as little as 400-500mA. The embedded resistor is designed to draw a current of about 1A (typical). If the current draw is insufficient to keep the power supply active, try reducing the value of the embedded resistor. Shorting out the W1 footprint, on the back side of the board, effectively shorts out 1/4 of the resistive trace, increasing the current draw by 30%. Similarly, shorting out W2 reduces the trace by 50%, thus doubling the current draw from the +5V output. If either W1 or W2 are shorted, it is advised that active state operation time be reduced as to avoid severe overheating of the board (in case the 5V

current draw exceeds 1A). For most, if not all cases, neither W1 nor W2 need be shorted.

## Design Envelope

Although different computer systems might have different requirements, the HIP6500BEVAL1 and HIP6502BEVAL1 boards were designed to meet the maximum output loading described in Tables 1 and 2. Note the fact that the addition of all the sleep state output currents exceeds the typical ATX power supply 5VSB output capability (725mA). Real-life sleep state current requirement on each of the outputs could be lower, and their maximums should rarely all occur simultaneously. Output tolerances and current ratings (with the exception of the 2.5V<sub>CLK</sub>, 3.3V<sub>SB</sub>, and 2.5/3.3V<sub>MEM</sub> when operating on internal pass transistors) can be adjusted by properly selecting the components external to the HIP6500B/02B.

**TABLE 1. HIP6500BEVAL1 MAXIMUM OUTPUT LOADING**

OUTPUT VOLTAGE	ACTIVE STATES		SLEEP STATES		TOL. (STATIC/DYNAMIC)
	I <sub>OUT</sub>	di <sub>OUT</sub> /dt	I <sub>OUT</sub>	di <sub>OUT</sub> /dt	
2.5V <sub>CLK</sub>	500mA	0.1A/μs	0	0	5%/5%
2.5/3.3V <sub>MEM</sub>	4A	1A/μs	250mA (Note)	1A/μs (Note)	5%/9%
3.3V <sub>SB</sub>	150mA	0.1A/μs	50mA	0.1A/μs	5%/5%
3.3V <sub>DUAL</sub>	3A	0.2A/μs	600mA	0.2A/μs	9%/9%
5V <sub>DUAL</sub>	2.5A	0.1A/μs	200mA	0.1A/μs	9%/9%

NOTE: S3 State Only.

**TABLE 2. HIP6502BEVAL1 MAXIMUM OUTPUT LOADING**

OUTPUT VOLTAGE	ACTIVE STATES		SLEEP STATES		TOL. (STATIC/DYNAMIC)
	I <sub>OUT</sub>	di <sub>OUT</sub> /dt	I <sub>OUT</sub>	di <sub>OUT</sub> /dt	
2.5V <sub>CLK</sub>	500mA	0.1A/μs	0	0	5%/5%
2.5V <sub>MEM</sub>	4A	1A/μs	250mA (Note)	1A/μs (Note)	5%/9%
3.3V <sub>MEM</sub>	4A	1A/μs	250mA (Note)	1A/μs (Note)	5%/9%
3.3V <sub>DUAL</sub> / 3.3V <sub>SB</sub>	3A	0.2A/μs	600mA	0.2A/μs	9%/9%
5V <sub>DUAL</sub>	2.5A	0.1A/μs	200mA	0.1A/μs	9%/9%

NOTE: S3 State Only.

The maximum current supported on the 2.5V<sub>MEM</sub> output (systems employing RDRAM memory) is as high as 7-8A. From a thermal performance perspective, do not operate the evaluation board for extended periods of time at output current levels exceeding the design envelope, as detailed in Tables 1 and 2.

## HIP6500B/02BEVAL1 Performance

Figures 2 through 6 depict the evaluation board's performance during a few typical operational situations. To simulate minimum loading conditions, unless otherwise specified, the outputs were loaded with 65Ω resistive loads.

### Sleep-State Start-Up

Figure 2 shows a typical HIP6500BEVAL1 start-up into S3 sleep state while all outputs are enabled (EN3V<sub>DCL</sub> = 0, EN5V<sub>DCL</sub> = 1). As 5VSB is applied to the board, SW1 and SW3 are off, while SW2 is on. At time T0 the input supply exceeds the power-on-reset (POR) threshold. Three milliseconds afterwards, at time T1, the soft-start clamp is removed and the 3.3V<sub>SB</sub> output starts to ramp up toward its target value, which it reaches at time T2. As its ramping ends shortly after bringing up this first output, the soft-start voltage is quickly brought down and prepared for a second soft-start designed to bring up the remainder of the controlled voltages that are supported in this configuration and state. This second ramp-up begins at time T3 and ends at time T4. The 5V<sub>DUAL</sub> output has a slightly different ramp-up than the remainder of the output voltages. The 5V<sub>DUAL</sub> output is not actively regulated, as is the case with the 2.5V<sub>MEM</sub> and 3.3V<sub>DUAL</sub> outputs in S3, but rather switched on through a P-MOS or PNP switch. An error amplifier is thus provided for the 5V<sub>DUAL</sub> output just for the purpose of providing a smooth, controlled output voltage rise. This error amplifier uses a different, soft-start derived, ramp signal to achieve the controlled rise of the output.

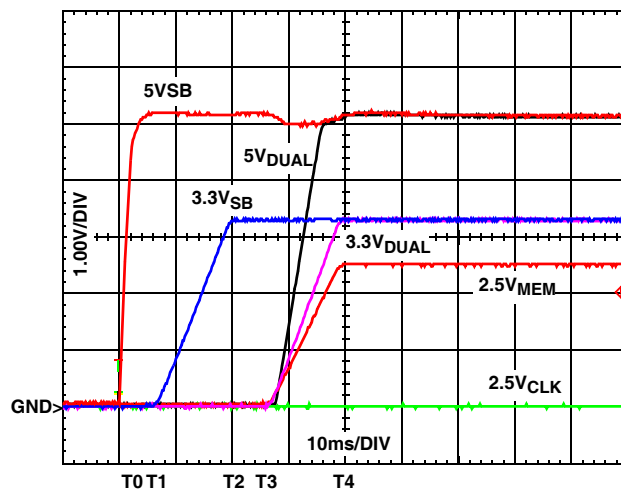

**FIGURE 2. HIP6500BEVAL1 START-UP IN SLEEP STATE (S3) WITH ALL OUTPUTS ENABLED**

Figure 3 shows a typical HIP6502BEVAL1 start-up into S3 sleep state while all outputs are enabled (MSEL = open, EN5VDL = 1). The start-up sequence is similar to that of the HIP6500BEVAL1 board, with the difference that the new 3.3V<sub>DUAL/SB</sub> output precedes all the other outputs, and the 3.3V<sub>MEM</sub> output replaces the 3.3V<sub>DUAL</sub>.

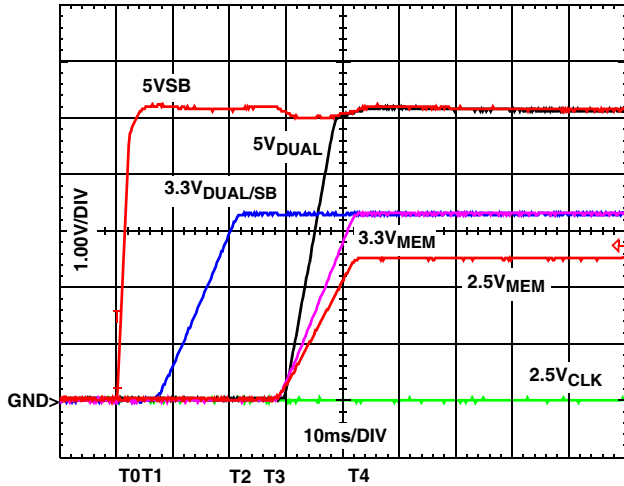

FIGURE 3. HIP6502BEVAL1 START-UP IN SLEEP STATE (S3) WITH ALL OUTPUTS ENABLED

**Active-State Start-Up**

Figure 4 also shows a start-up sequence, but this time into an active state (S0, S1). As the enable pins only configure the sleep state voltage support, this start-up sequence will be the same, regardless of EN3VDL and EN5VDL status. In Figure 4, SW1, SW2 and SW3 are all off and 5VSB is applied to the HIP6500BEVAL1 board. Active state operation is enabled by switching on SW1, a few milliseconds before T0. Invariably, the 3.3V<sub>SB</sub> output is brought up shortly after 5VSB is applied to the IC, and it can be seen present at the time the main ATX outputs are coming up (T0). At time T0, the input voltages (3.3V, 5V, 12V) exceed the under-voltage thresholds (12V shown, only) and the internal 25ms (typical) timer is initiated. Note the typically poor regulation of the ATX supply resulting in a 10% overshoot at start-up (T0). Between T0 and T1, the 3.3V<sub>DUAL</sub> and 5V<sub>DUAL</sub> outputs undergo a quasi soft-start, due to conduction through the body diodes of the active N-MOS switches (Q4 and Q6). At time T1 the timer expires and the two N-MOS transistors are turned on; simultaneously, the 2.5V<sub>MEM</sub> and 2.5V<sub>CLK</sub> outputs begin a soft-start cycle, reaching regulation limits at time T2.

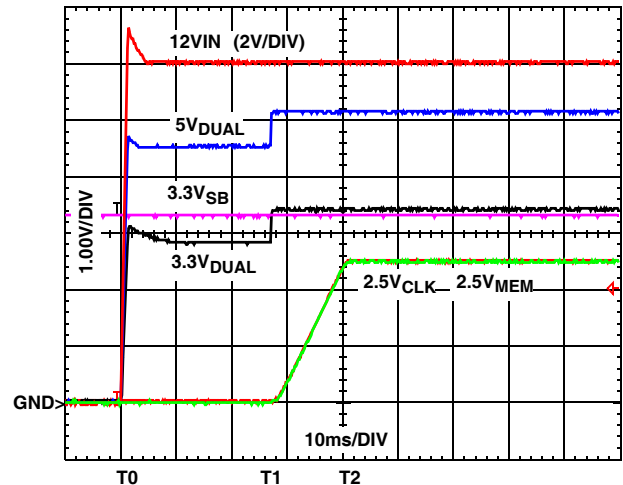

FIGURE 4. HIP6500BEVAL1 START-UP IN ACTIVE STATE (S0, S1) WITH ALL OUTPUTS ENABLED

Figure 5 shows the same start-up sequence into an active state (S0, S1) on the HIP6502BEVAL1 evaluation board. Except for the noted different output use and designator differences, the start-up sequences of the boards are extremely similar.

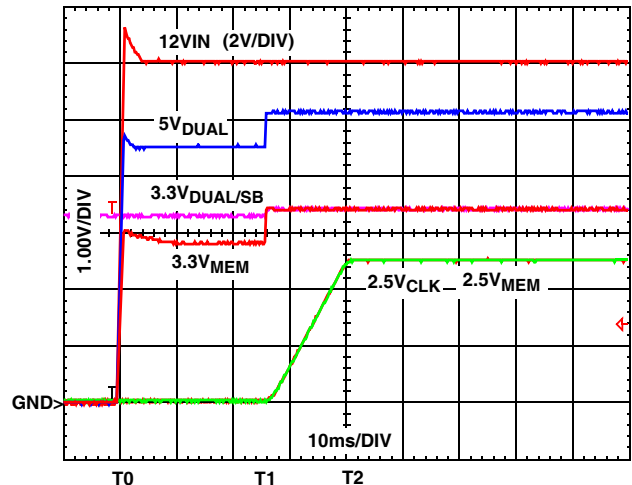
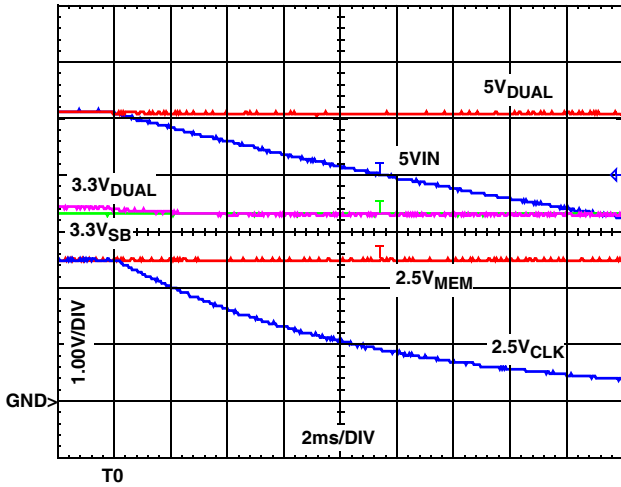

FIGURE 5. HIP6502BEVAL1 START-UP IN ACTIVE STATE (S0, S1) WITH ALL OUTPUTS ENABLED

**State Transitions**

Figure 6 shows the transition from active state (S0, S1) to S3 sleep state on the HIP6500BEVAL1 board. Prior to time T0, the evaluation board was operating in active mode, with SW1 on and SW2 and SW3 off. At time T0, SW2 is switched on, triggering the turn-off of the ATX and the switch-over of the output regulation from the active ATX output rails to the 5VSB supply. Very shortly after time T0, the ATX responds to the turn-off request, and the 5V input starts to ramp down under the current drawn by the embedded 5Ω serpentine resistor. As it can be noticed in the scope capture, the transitions are devoid of any perturbations. These smooth transitions are desirable in a computer system, power glitches being the leading cause of power-related system crashes.



**FIGURE 6. HIP6500BEVAL1 ACTIVE STATE (S0, S1) TO STANDBY STATE (S3) TRANSITION WITH ALL OUTPUTS ENABLED**

Figure 7 shows the transition from active state (S0, S1) to S3 sleep state on the HIP6502BEVAL1 board. Similarly, this board mirrors the functionality and benefits of the HIP6500BEVAL1.

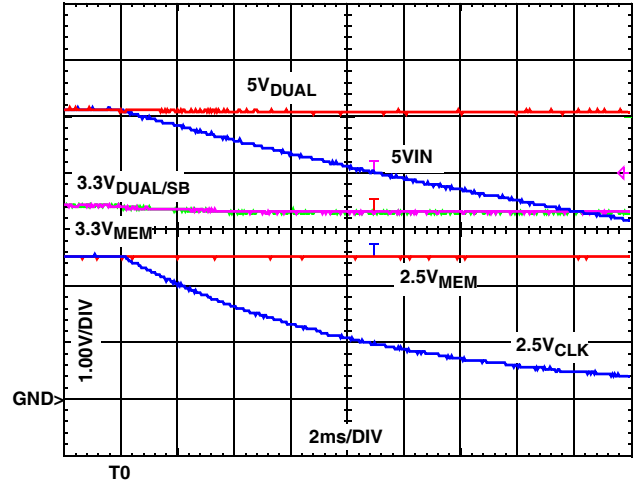

**FIGURE 7. HIP6502BEVAL1 ACTIVE STATE (S0, S1) TO STANDBY STATE (S3) TRANSITION WITH ALL OUTPUTS ENABLED**

Figure 8 highlights the transition back from S3 sleep state to active state (S0, S1) with all outputs enabled, as captured on the HIP6500BEVAL1 board. At time T0, SW2 is switched off, enabling the main ATX outputs. As 3.3VIN, 5VIN, and 12VIN exceed their undervoltage thresholds, the 25ms timer internal to the HIP6500B is initiated. At T1 the time-out expires, conduction on the 3.3V\_DUAL and 5V\_DUAL outputs is transferred to the N-MOS switches and the 2.5V\_CLK output begins its ramp-up. At time T2, all the outputs are functional and ready for active state operation. The 2.5V\_MEM output is maintained glitch-free throughout the input voltage transition from the standby to the main ATX outputs.

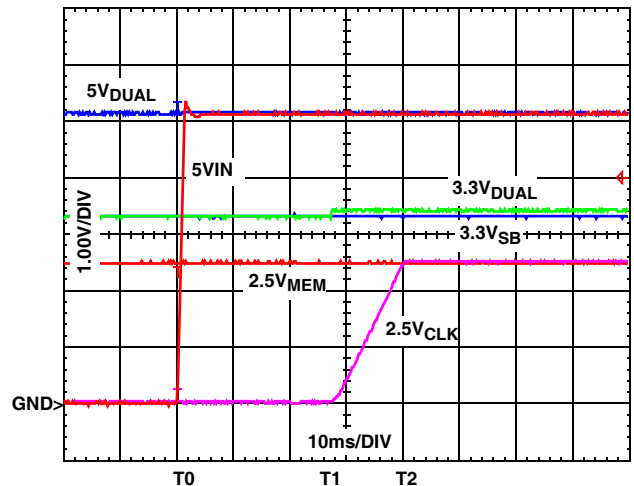

**FIGURE 8. HIP6500BEVAL1 STANDBY STATE (S3) TO ACTIVE STATE (S0, S1) TRANSITION WITH ALL OUTPUTS ENABLED**

Figure 9 highlights the transition from S5 sleep state to active state (S0, S1) with no outputs enabled (3.3V<sub>SB</sub> is always enabled), as captured on the HIP6500BEVAL1 board. At time T0, SW2 is switched off, enabling the main ATX outputs. As 3.3V<sub>IN</sub>, 5V<sub>IN</sub>, and 12V<sub>IN</sub> exceed their undervoltage thresholds (5V<sub>IN</sub> shown, only), the 25ms timer internal to the HIP6500B is initiated and similar to the start-up shown in Figure 8, the 3V<sub>DUAL</sub> and 5V<sub>DUAL</sub> outputs undergo a quasi-soft-start as conduction takes place through the body diodes of the pass NMOS switches. At T1 the time-out expires, conduction on the 3.3V<sub>DUAL</sub> and 5V<sub>DUAL</sub> outputs is transferred to the N-MOS switches and the 2.5V<sub>CLK</sub> and 2.5V<sub>MEM</sub> outputs begin their ramp-up. At time T2, all the outputs are functional and ready for active state operation.

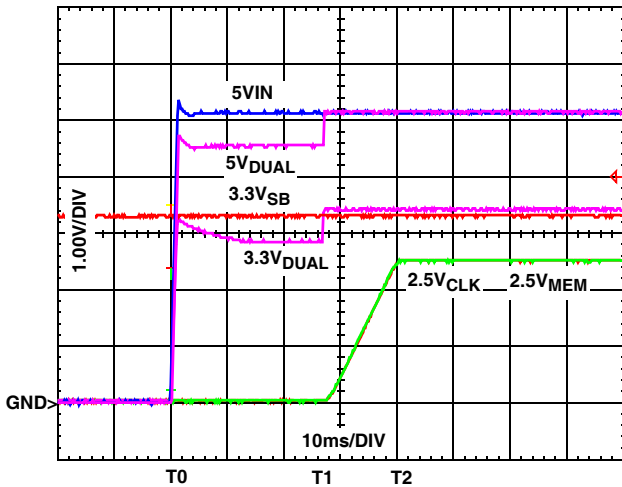

FIGURE 9. HIP6500BEVAL1 STANDBY STATE (S5) TO ACTIVE STATE (S0, S1) TRANSITION WITH NO OUTPUTS ENABLED

The 25ms time-out employed by the HIP6500B (and HIP6502B) is necessary in order to insure that the main ATX outputs are allowed to stabilize and reach regulation limits before any circuits are connected to, or are allowed to derive their voltages from them. This technique insures glitch-free operation, compatible with virtually any ATX power supply.

### Transient Response

Given the similarity of the two evaluation boards, only HIP6500BEVAL1 results are shown in Figures 10-12; the respective outputs of the HIP6502BEVAL1 exhibit similar performance. All outputs shown in the oscilloscope captures are DC offset by their nominal value and are DC coupled. The current waveforms underneath each of the output voltage waveforms show the (transient) current drawn from the respective output.

In Figure 10, the outputs shown are separately subjected to load transients while operating in active state (S0, S1).

Transient loading of the outputs is as follows:

- 2.5V<sub>MEM</sub>: 500mA to 3.2A at 1A/ $\mu$ s
- 2.5V<sub>CLK</sub>: 180mA to 700mA at 0.1A/ $\mu$ s

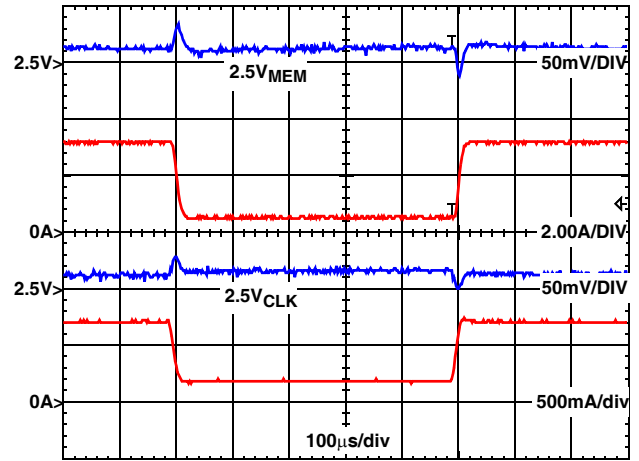

FIGURE 10. HIP6500BEVAL1 ACTIVE STATE (S0, S1) OUTPUT TRANSIENT RESPONSE

In Figure 11, the outputs shown are separately subjected to load transients while operating in active state (S0, S1).

Transient loading of the outputs is as follows:

- 3.3V<sub>DUAL</sub>: 500mA to 3.2A at 0.2A/ $\mu$ s
- 5V<sub>DUAL</sub>: 200mA to 2.5A at 0.1A/ $\mu$ s

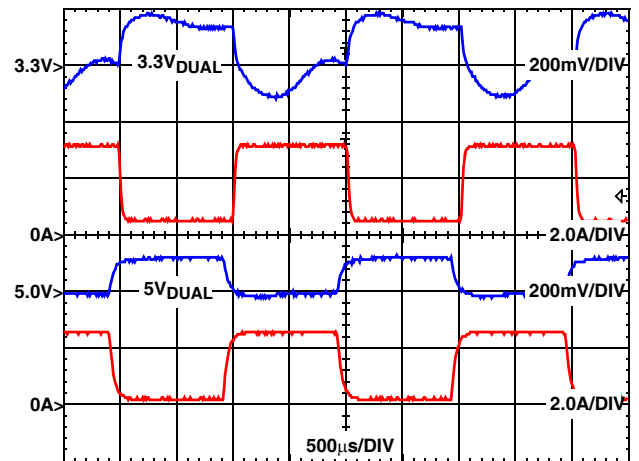

FIGURE 11. HIP6500BEVAL1 ACTIVE STATE (S0, S1) OUTPUT TRANSIENT RESPONSE

The 3.3V<sub>DUAL</sub> and 5V<sub>DUAL</sub> outputs closely follow the AC meandering of the ATX 3.3V and 5V outputs, being separated only by the  $r_{DS(ON)}$  of the N-MOS switches (Q4 and Q6). During the transient loading, the 3.3V<sub>DUAL</sub> output develops a DC offset (compared to the ATX 3.3V), due to the voltage droop across Q4. Specific to this circuit and the particular circuit loading, the offset can easily be identified as the product of the  $r_{DS(ON)}$  of the pass transistor and the output current. A similar explanation accompanies the 5V<sub>DUAL</sub> output waveform.

In Figure 12, the outputs shown are separately subjected to load transients while operating in sleep state (S3). Transient loading of the outputs is as follows:

- 2.5V<sub>MEM</sub>: 50mA to 200mA at 1A/μs
- 3.3V<sub>SB</sub>: 30mA to 200mA at 0.1A/μs

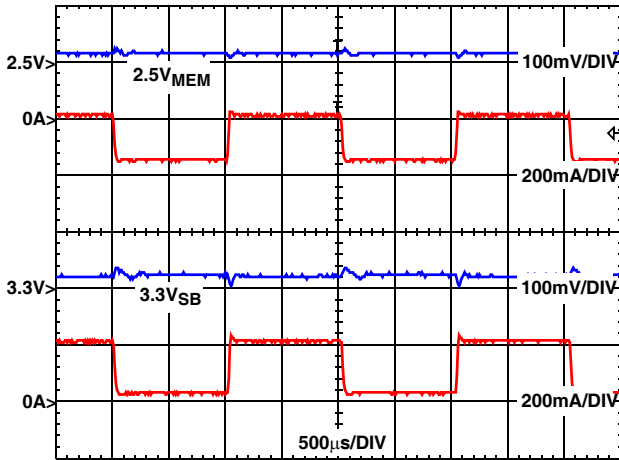

FIGURE 12. HIP6500BEVAL1 SLEEP STATE (S3) OUTPUT TRANSIENT RESPONSE

### Output Short-Circuit Protection

Figure 13 depicts the circuit's behavior in response to a sudden output short-circuit (output under-voltage), applied, in this scope capture, on the 2.5V<sub>MEM</sub> output, while operating in active state. At time T0 a short-circuit is applied using an electronic load - as a result, the 2.5V output starts to rapidly discharge, crossing the falling under-voltage threshold at time T1. To avoid false triggers, the UV detector is equipped with a 10μs filter. As the output voltage remains below the undervoltage (UV) threshold for more than 10μs, it triggers a fault response at time T2. The logic high output on the FAULT pin sets the external fault latch circuitry which shuts down the ATX supply and quickly discharges the SS capacitor below the chip shutdown level, reached at time T3. The chip reset disables the fault reporting and the latch maintains the circuit in a reset state. The latch is necessary to compensate for the slow response of the ATX supply, by shutting down the controller IC, along with the pass elements. Depressing the CLEAR FAULT button resets the latch and releases the circuit for operation.

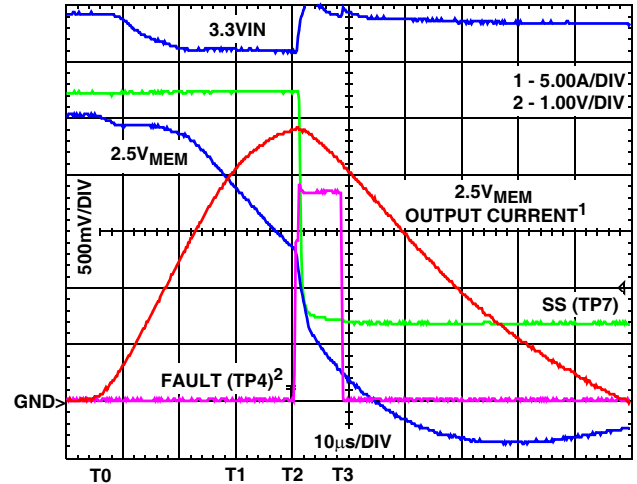

FIGURE 13. HIP6500BEVAL1 2.5V<sub>MEM</sub> OUTPUT UNDERVOLTAGE RESPONSE WHILE IN ACTIVE STATE (S0, S1)

### HIP6500B/02BEVAL1 Modifications

#### Setting the 2.5/3.3V<sub>MEM</sub> Output to 3.3V (HIP6500BEVAL1 Only)

The HIP6500BEVAL1 evaluation board ships populated to demonstrate support for RDRAM or some double data rate (DDR) SDRAM memory, with the memory output set for 2.5V. The HIP6500B, however, is designed for either 2.5V or 3.3V memory output voltage. To change the memory output voltage on the evaluation board perform the following steps:

- Replace R3 with a 15kΩ resistor
- Remove Q2, and install an N-MOS transistor in its place (HUF76113 or equivalent recommended). Please note the connection diagram and insure the correct connections are established (N-MOS might not fit the provided footprint)

With the above modifications, the memory output will be set to 3.3V. In this configuration, the output voltage obtainable in active state is directly related to the ATX 3.3V output, the memory output current, and the  $r_{(DS)ON}$  of Q2, according to the following equation:

$$V_{MEM} = V_{IN} - I_{MEM} \times r_{(DS)ON}$$

#### Improving Output Voltage Tolerance

The key to improving the output voltage tolerance is identifying the parameters which affect it, and then taking steps toward improving them.

The output DC voltage droop on the 3.3V<sub>DUAL</sub> and 5V<sub>DUAL</sub> outputs under applied load is due to the resistive losses across the N-MOS switch's own  $r_{(DS)ON}$  - decreasing the  $r_{(DS)ON}$  results in reduced load-dependent voltage drooping.

High  $dV/dt$  spikes present in the output voltage waveform under highly dynamic load application (high  $dI/dt$ ) are due to the ESR and the ESL of the output capacitance. These spikes coincide with the transient load's rising and falling edges, and decreasing their amplitude can be achieved by using lower ESR/ESL output capacitors (such as surface-mount tantalum capacitors), and/or the addition of more ceramic capacitors, which have inherently low ESR/ESL.

The addition of more input-side capacitance and decreasing the input-side capacitor banks' ESR can also help in situations where the input-side ripple is affecting the output regulation. Such an example is excessive ATX 3.3V ripple reducing the collector-to-emitter voltage available for Q2 (2.5V setting), and thus inducing an output droop component - in such instance, the addition of input-side capacitance and reduction of the ESR component can reduce the output excursion.

### Conclusion

The HIP6500B and HIP6502B are sophisticated integrated circuits that envelop all the required circuitry for ACPI implementation in computer motherboards and computer systems. The circuits employ intelligent switching methods for smooth power plane transitions, noise immunity circuits for nuisance trip avoidance, and a direct interface to the south bridge and logical circuitry for simplified control and configuration.

### References

For Intersil documents available on the internet, see web site <http://www.intersil.com/>

- [1] Advanced Configuration and Power Interface Specification, Revision 1.0, December 1996, Intel/Microsoft/Toshiba. (<http://www.teleport.com/~acpi/>).
- [2] *HIP6020 Data Sheet*, Intersil Corporation, Power Management Products Division, FN4683, (<http://www.intersil.com/>).
- [3] *HIP6021 Data Sheet*, Intersil Corporation, Power Management Products Division, FN4684.
- [4] ATX Specification, Version 2.02, October 1998, Intel Corporation (<http://www.teleport.com/~atx/>).
- [5] *HIP6500B Data Sheet*, Intersil Corporation, Power Management Products Division, FN4870.
- [6] *HIP6502B Data Sheet*, Intersil Corporation, Power Management Products Division, FN4871.



HIP6500BEVAL1 Schematic

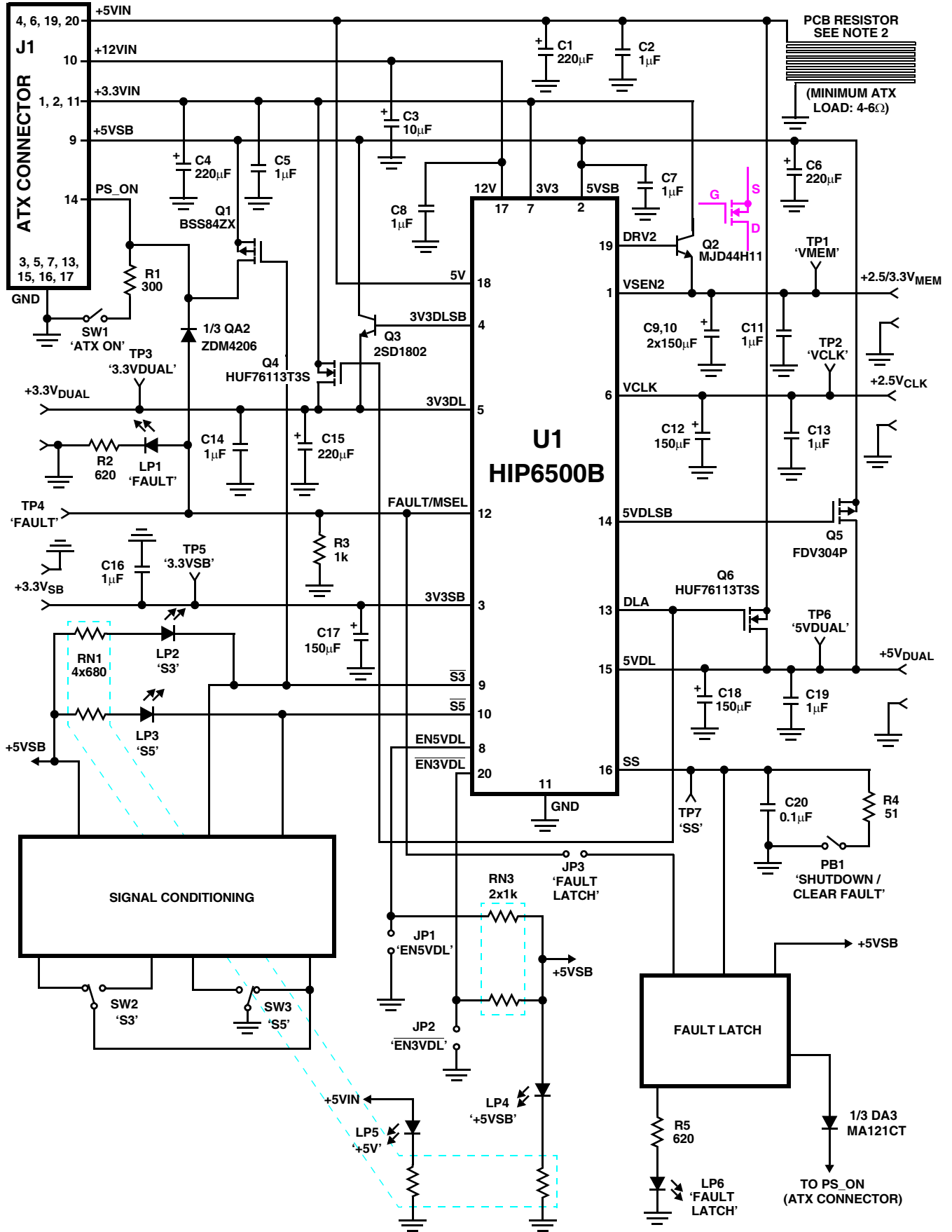

HIP6502BEVAL1 Schematic

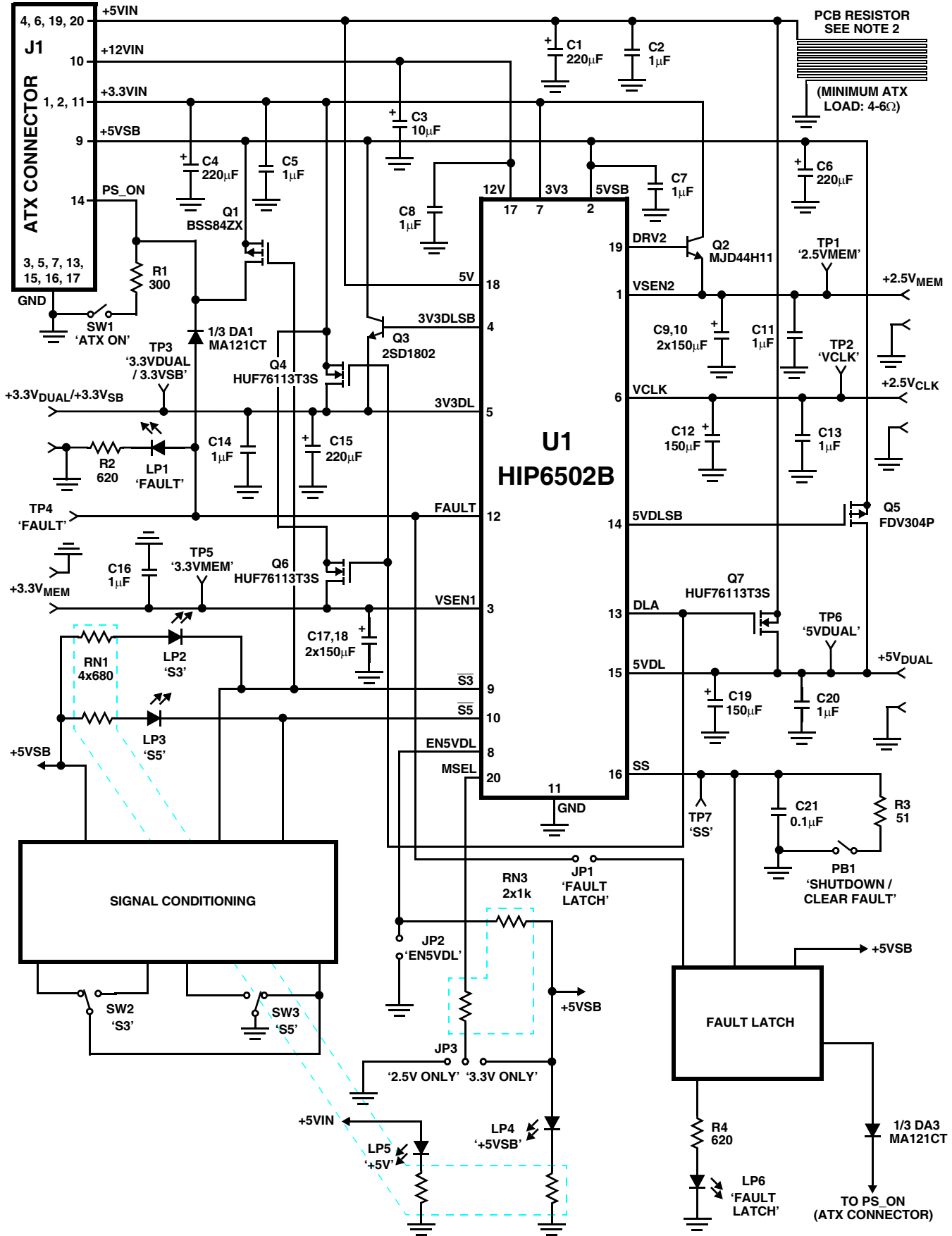

Signal Conditioning and Fault Latch Circuits

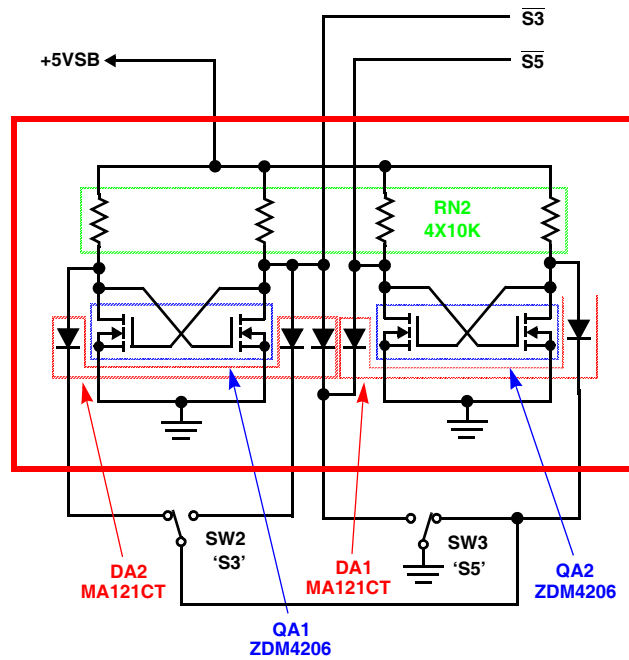

FIGURE 14. SIGNAL CONDITIONING BLOCK

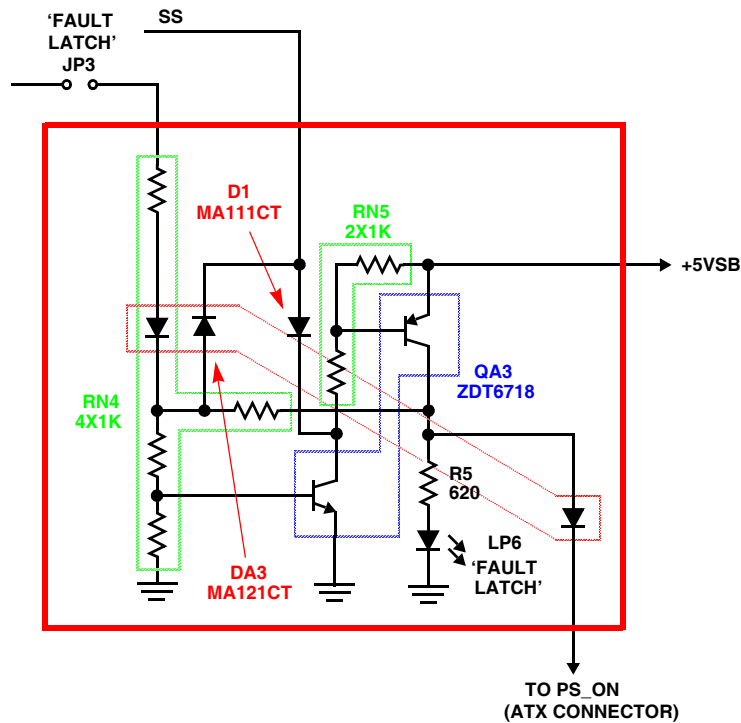

FIGURE 15. FAULT LATCHING BLOCK

## Application Note 9862

### Bill of Materials for HIP6500BEVAL1

REF	PART NO.	DESCRIPTION	PACKAGE	QTY	VENDOR
C1, 4, 6, 15	EEUFC1E221	Aluminum Electrolytic Capacitor, 25V, 220 $\mu$ F, 117m $\Omega$	8 x 11.5	4	Panasonic
C3	TAJC106M020R	Tantalum Capacitor, 20V, 10 $\mu$ F, 2 $\Omega$	3.2 x 6.0	1	AVX
C2, 5, 7, 8, 11, 13, 14, 16, 19	1 $\mu$ F Ceramic	Ceramic Capacitor, Y5V, 16V, 1.0 $\mu$ F	0805	9	Any
C9, 10, 12, 17, 18	EEUFC1V151	Al. Electrolytic Capacitor, 35V, 150 $\mu$ F, 117m $\Omega$	8 x 11.5	5	Panasonic
C20	0603YC104MAT2A	Ceramic Capacitor, X7R, 16V, 0.1 $\mu$ F	0603	1	AVX
D1	MA111CT-ND	Switching Diode, 80V, 100mA	Mini 2P	1	Digikey
DA1-3	MA121CT-ND	Diode Array, 80V, 100mA	Mini 6P	3	Digikey
J1	39-29-9203	20-pin Mini-Fit, Jr.™ Header Connector		1	Molex
JP1-3	68000-236	Jumper Header	0.1" spacing	6/36	Berg
	71363-102	Jumper Shunt	0.1" spacing	3	Berg
LP1-6	L63111CT-ND	Miniature LED, Through-Board Indicator		6	Digikey
PB1	P8007S-ND	Push-Button, Miniature		1	Digikey
Q1	BSS84ZXCT-ND	Logic P-MOSFET, 50V, 10 $\Omega$	SOT-23	1	Digikey
Q2 (Note 1)	MJD44H11	NPN Bipolar, 80V, 8A	TO-252AA	1	Motorola
Q3	2SD1802	NPN Bipolar, 50V, 3A	TO-252AA	1	Sanyo
Q4,6	HUF76113T3S	UltraFET™ MOSFET, 30V, 31m $\Omega$	SOT-223	2	Intersil
Q5	FDV304P	Logic P-MOSFET, 25V, 1.5 $\Omega$	SOT-23	1	Fairchild
QA1, 2	ZDM4206NCT-ND	Small-Signal Dual MOSFET, 60V, 1 $\Omega$	SM-8	2	Digikey
QA3	ZDT6718CT-ND	Small-Signal Bipolar Pair, 20V, 1.5A	SM-8	1	Digikey
R1	300 $\Omega$	Resistor, 5%, 0.1W	0603	1	Any
R2, 5	620 $\Omega$	Resistor, 5%, 0.1W	0603	2	Any
R3 (Note 2)	1.0k $\Omega$	Resistor, 5%, 0.1W	0603	1	Any
R4	51 $\Omega$	Resistor, 5%, 0.1W	0603	1	Any
RN1	Y9681CT-ND	4-Resistor Network, 680 $\Omega$ , 5%, 0.1W	3.2 x 1.6	1	Digikey
RN2	Y9103CT-ND	4-Resistor Network, 10k $\Omega$ , 5%, 0.1W	3.2 x 1.6	1	Digikey
RN3, 5	Y8102CT-ND	2-Resistor Network, 1k $\Omega$ , 5%, 0.1W	1.6 x 1.6	2	Digikey
RN4	Y9102CT-ND	4-Resistor Network, 1k $\Omega$ , 5%, 0.1W	3.2 x 1.6	1	Digikey
SW1	GT12MSCKE	Miniature Switch, Single Pole, Single Throw		1	C&K
SW2, 3	GT11MSCKE	Miniature Switch, Single Pole, Double Throw		2	C&K
TP1-3, 5, 6	1314353-00	Test Point, Scope Probe		5	Tektronics
TP4, 7	SPCJ-123-01	Test Point		2	Jolo
U1	HIP6500BCB	ACPI Multiple Linear Controller	SOIC-20	1	Intersil
+2.5/3.3V <sub>MEM</sub> , +2.5V <sub>CLK</sub> , +3.3V <sub>DUAL</sub> , +3.3V <sub>SB</sub> , +5V <sub>DUAL</sub> , GND	1514-2	Terminal Post		10	Keystone

**NOTES:**

- Q2 has to be replaced by an NMOS transistor when 3.3V  $V_{MEM}$  output is desired (see circuit diagram for proper connection).
- R3 has to be replaced by a 15k $\Omega$  resistor when 3.3V  $V_{MEM}$  output is desired.

## Application Note 9862

### Bill of Materials for HIP6502BEVAL1

REF	PART #	DESCRIPTION	PACKAGE	QTY	VENDOR
C1, 4, 6, 15	EEUFC1E221	Aluminum Electrolytic Capacitor, 25V, 220 $\mu$ F, 117m $\Omega$	8 x 11.5	4	Panasonic
C3	TAJC106M020R	Tantalum Capacitor, 20V, 10 $\mu$ F, 2 $\Omega$	3.2 x 6.0	1	AVX
C2, 5, 7, 8, 11, 13, 14, 16, 20	1 $\mu$ F Ceramic	Ceramic Capacitor, Y5V, 16V, 1.0 $\mu$ F	0805	9	Any
C9, 10, 12, 17-19	EEUFC1V151	Al. Electrolytic Capacitor, 35V, 150 $\mu$ F, 117m $\Omega$	8 x 11.5	6	Panasonic
C21	0603YC104MAT2A	Ceramic Capacitor, X7R, 16V, 0.1 $\mu$ F	0603	1	AVX
D1	MA111CT-ND	Switching Diode, 80V, 100mA	Mini 2P	1	Digikey
DA1-3	MA121CT-ND	Diode Array, 80V, 100mA	Mini 6P	3	Digikey
J1	39-29-9203	20-pin Mini-Fit, Jr.™ Header Connector		1	Molex
JP1-3	68000-236	Jumper Header	0.1" spacing	7/36	Berg
	71363-102	Jumper Shunt	0.1" spacing	3	Berg
LP1-6	L63111CT-ND	Miniature LED, Through-Board Indicator		6	Digikey
PB1	P8007S-ND	Push-Button, Miniature		1	Digikey
Q1	BSS84ZXCT-ND	Logic P-MOSFET, 50V, 10 $\Omega$	SOT-23	1	Digikey
Q2	MJD44H11	NPN Bipolar, 80V, 8A	TO-252AA	1	Motorola
Q3	2SD1802	NPN Bipolar, 50V, 3A	TO-252AA	1	Sanyo
Q4, 6, 7	HUF76113T3S	UltraFET™ MOSFET, 30V, 31m $\Omega$	SOT-223	3	Intersil
Q5	FDV304P	Logic P-MOSFET, 25V, 1.5 $\Omega$	SOT-23	1	Fairchild
QA1, 2	ZDM4206NCT-ND	Small-Signal Dual MOSFET, 60V, 1 $\Omega$	SM-8	2	Digikey
QA3	ZDT6718CT-ND	Small-Signal Bipolar Pair, 20V, 1.5A	SM-8	1	Digikey
R1	300 $\Omega$	Resistor, 5%, 0.1W	0603	1	Any
R2, 4	620 $\Omega$	Resistor, 5%, 0.1W	0603	2	Any
R3	51 $\Omega$	Resistor, 5%, 0.1W	0603	1	Any
RN1	Y9681CT-ND	4-Resistor Network, 680 $\Omega$ , 5%, 0.1W	3.2 x 1.6	1	Digikey
RN2	Y9103CT-ND	4-Resistor Network, 10k $\Omega$ , 5%, 0.1W	3.2 x 1.6	1	Digikey
RN3, 5	Y8102CT-ND	2-Resistor Network, 1k $\Omega$ , 5%, 0.1W	1.6 x 1.6	2	Digikey
RN4	Y9102CT-ND	4-Resistor Network, 1k $\Omega$ , 5%, 0.1W	3.2 x 1.6	1	Digikey
SW1	GT12MSCKE	Miniature Switch, Single Pole, Single Throw		1	C&K
SW2, 3	GT11MSCKE	Miniature Switch, Single Pole, Double Throw		2	C&K
TP1-3, 5, 6	1314353-00	Test Point, Scope Probe		5	Tektronics
TP4, 7	SPCJ-123-01	Test Point		2	Jolo
U1	HIP6502BCB	ACPI Multiple Linear Controller	SOIC-20	1	Intersil
+2.5V <sub>CLK</sub> , +2.5V <sub>MEM</sub> , +3.3V <sub>MEM</sub> , +3.3V <sub>DUAL</sub> /3.3V <sub>SB</sub> , +5V <sub>DUAL</sub> , GND	1514-2	Terminal Post		10	Keystone

HIP6500BEVAL1 Layout

TOP SILK SCREEN

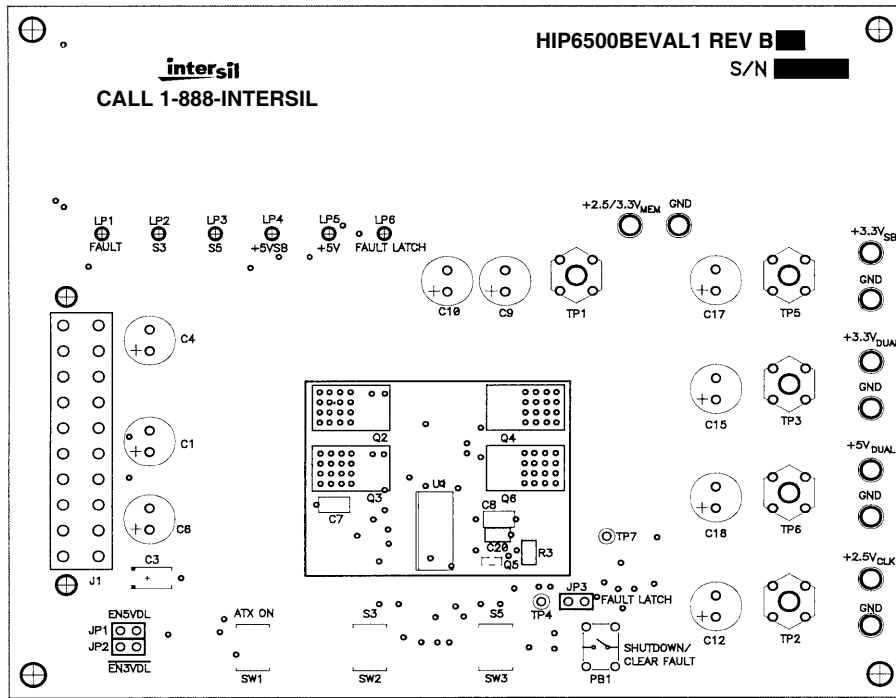

TOP LAYER

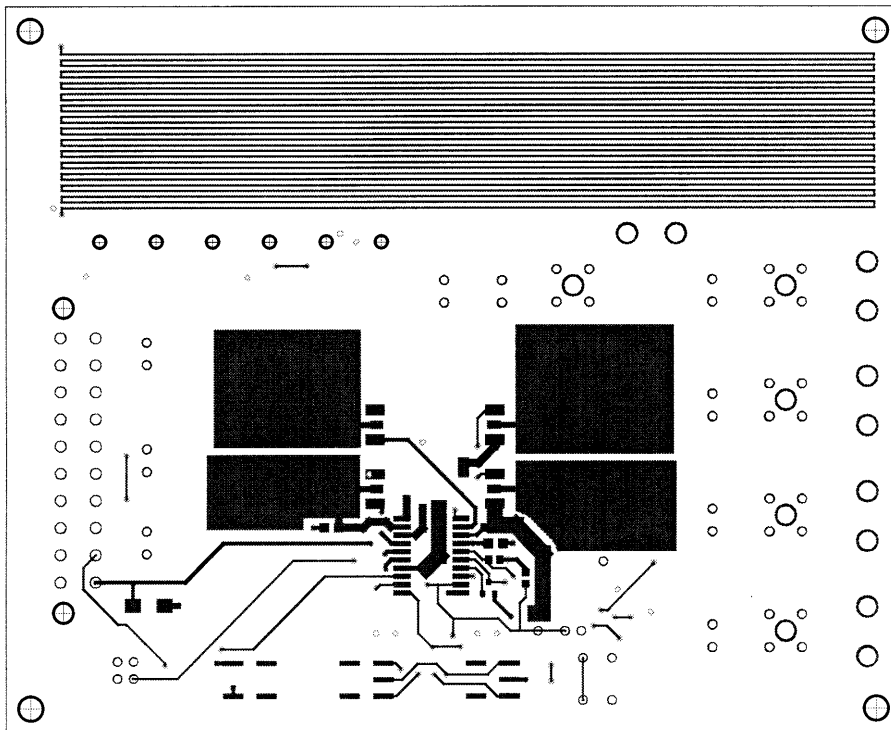

HIP6500BEVAL1 Layout (Continued)

GROUND LAYER

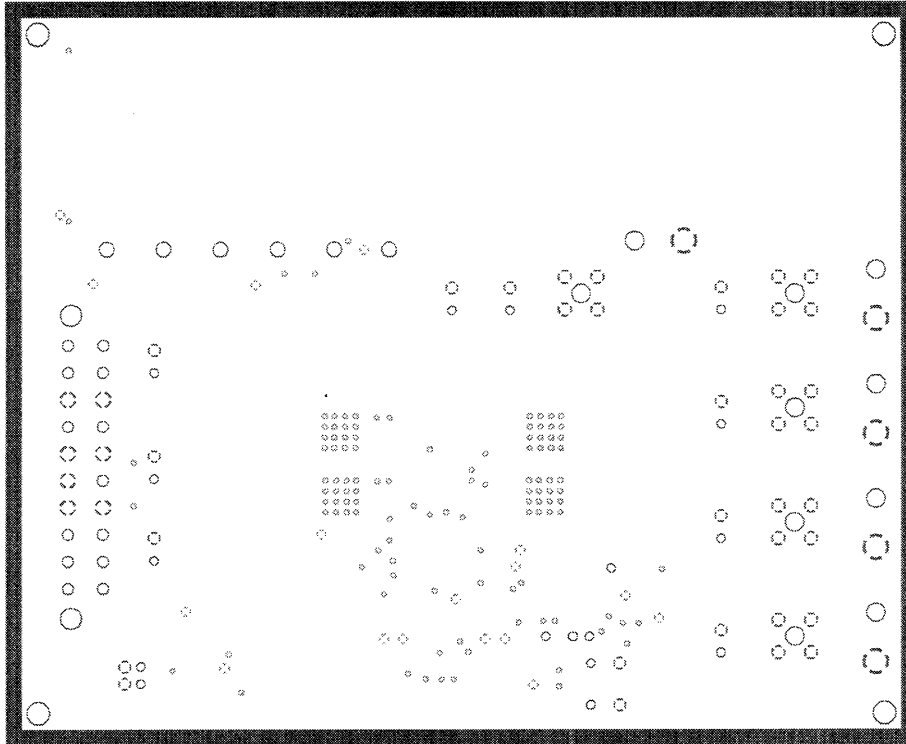

POWER LAYER

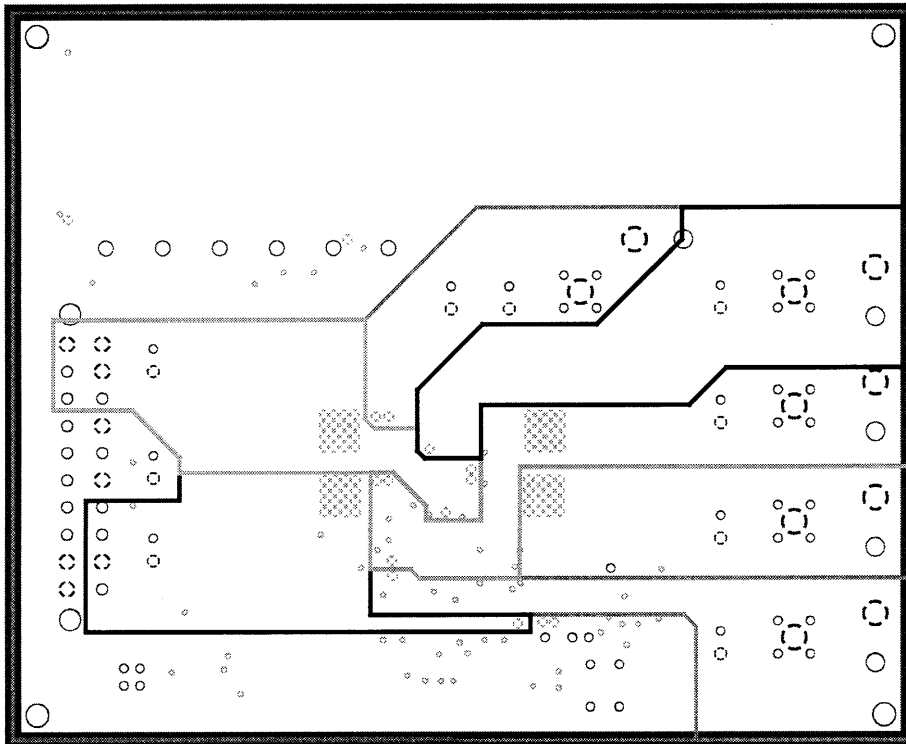





HIP6502BEVAL1 Layout

TOP SILK SCREEN

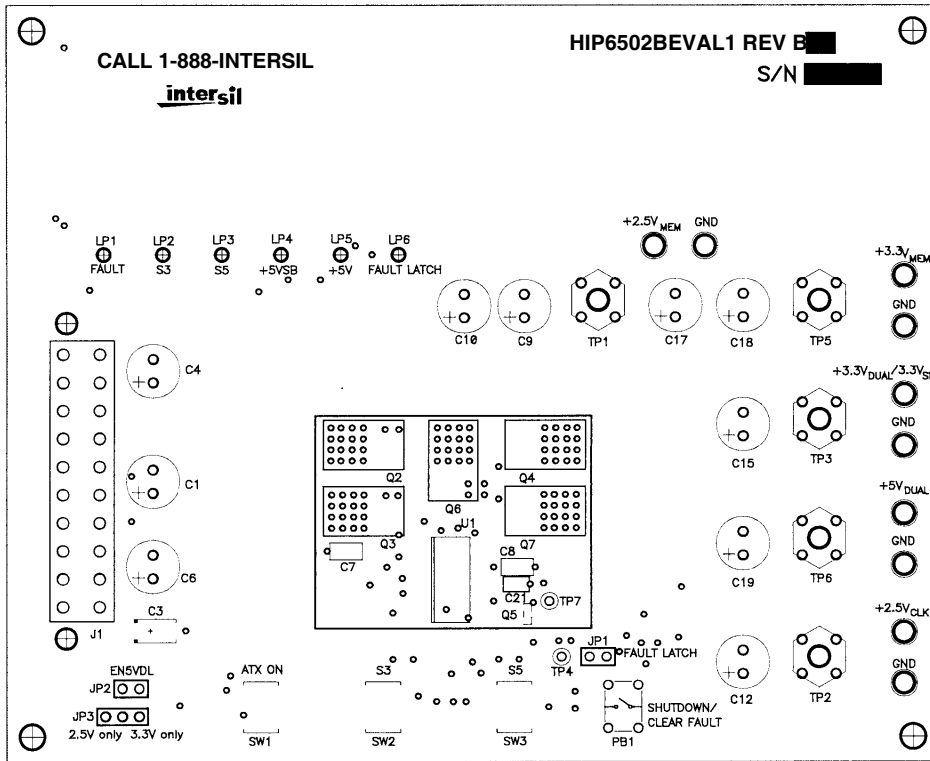

TOP LAYER

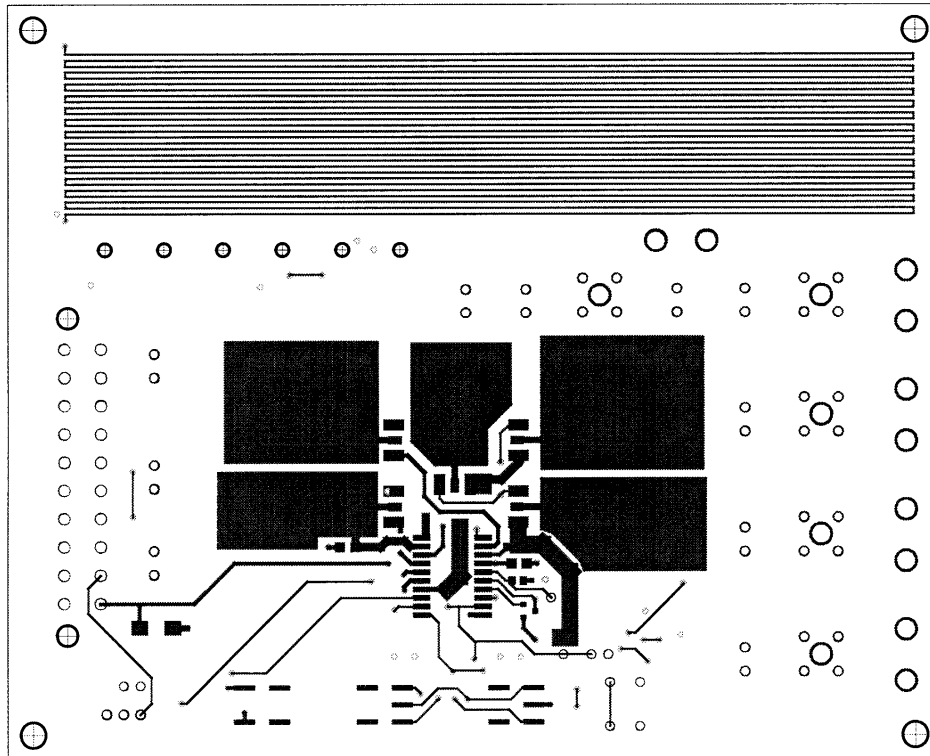

HIP6502BEVAL1 Layout (Continued)

GROUND LAYER

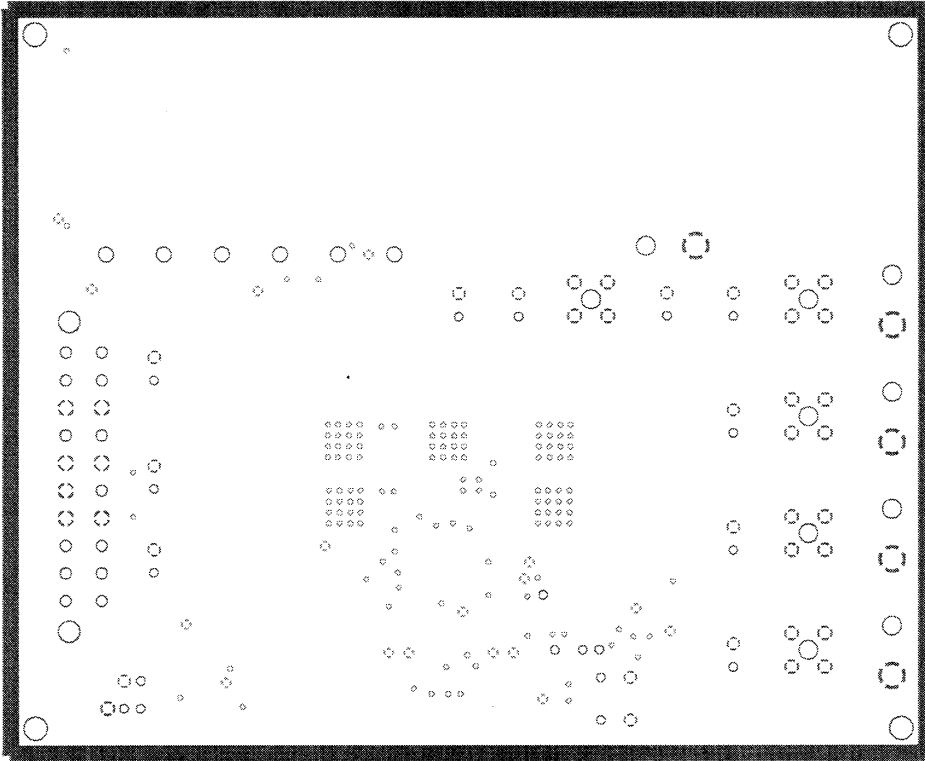

POWER LAYER

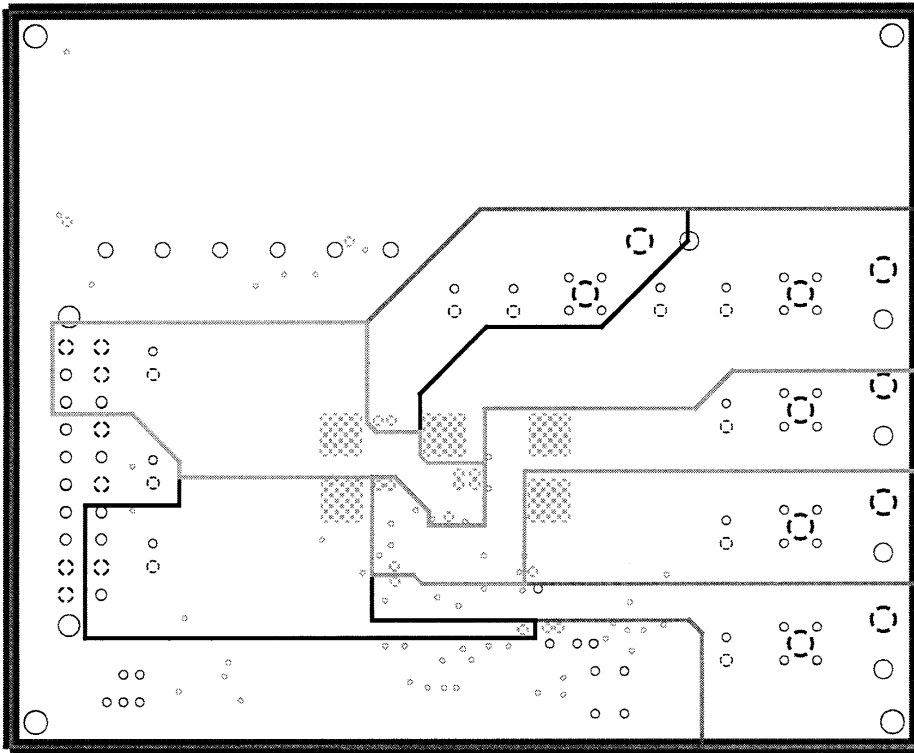

HIP6502BEVAL1 Layout (Continued)

BOTTOM LAYER

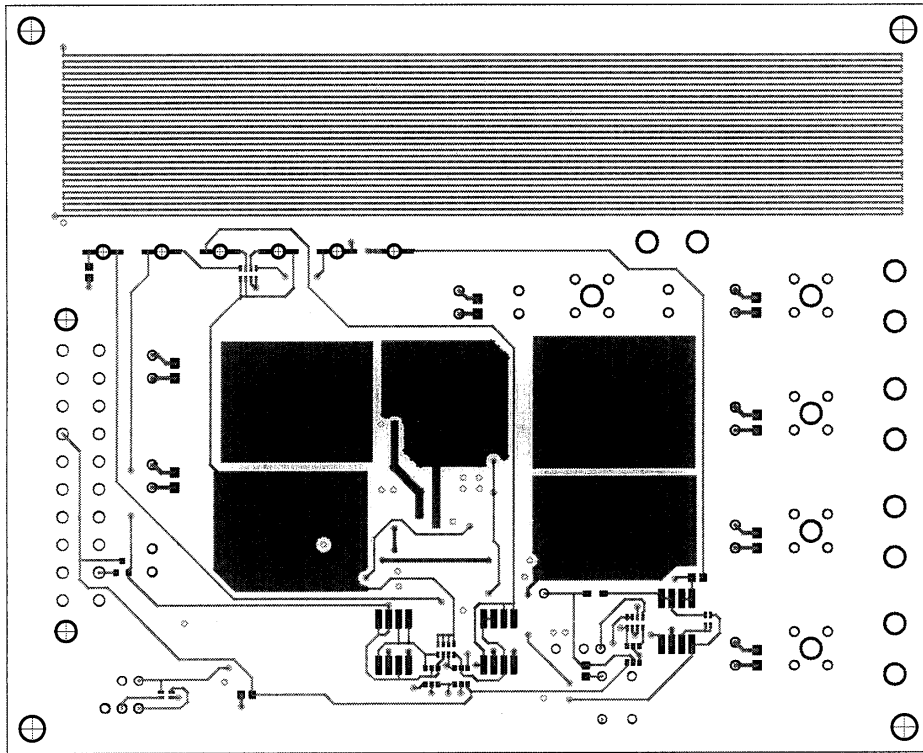

BOTTOM SILK SCREEN

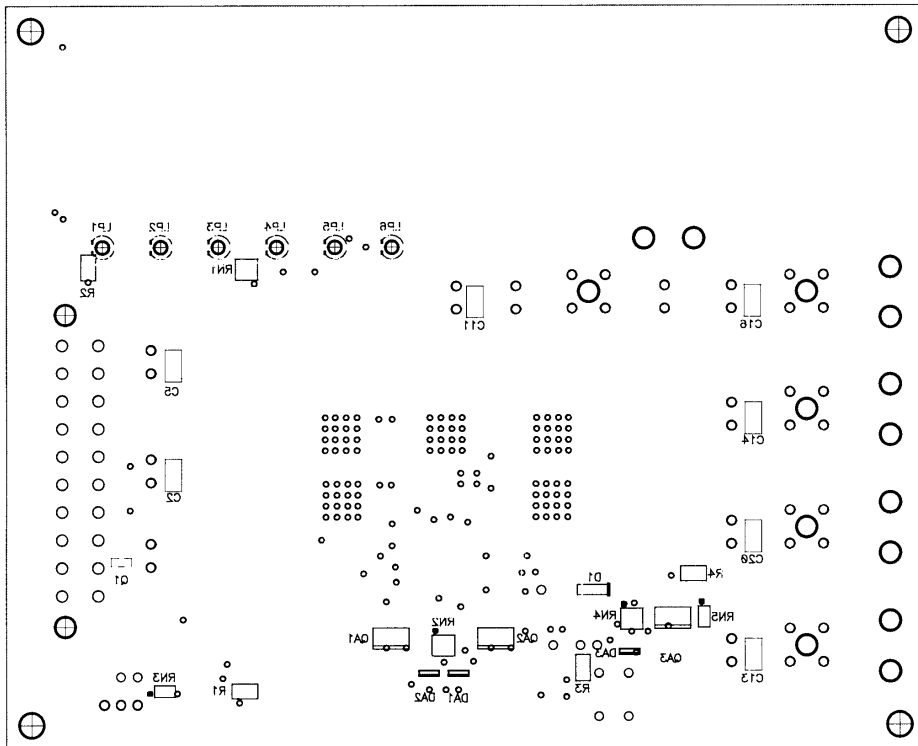

All Intersil semiconductor products are manufactured, assembled and tested under **ISO9000** quality systems certification.

*Intersil semiconductor products are sold by description only. Intersil Corporation reserves the right to make changes in circuit design and/or specifications at any time without notice. Accordingly, the reader is cautioned to verify that data sheets are current before placing orders. Information furnished by Intersil is believed to be accurate and reliable. However, no responsibility is assumed by Intersil or its subsidiaries for its use; nor for any infringements of patents or other rights of third parties which may result from its use. No license is granted by implication or otherwise under any patent or patent rights of Intersil or its subsidiaries.*

For information regarding Intersil Corporation and its products, see web site **www.intersil.com**

### **Sales Office Headquarters**

#### **NORTH AMERICA**

Intersil Corporation  
P. O. Box 883, Mail Stop 53-204  
Melbourne, FL 32902  
TEL: (321) 724-7000  
FAX: (321) 724-7240

#### **EUROPE**

Intersil SA  
Mercure Center  
100, Rue de la Fusee  
1130 Brussels, Belgium  
TEL: (32) 2.724.2111  
FAX: (32) 2.724.22.05

#### **ASIA**

Intersil Ltd.  
8F-2, 96, Sec. 1, Chien-kuo North,  
Taipei, Taiwan 104  
Republic of China  
TEL: 886-2-2515-8508  
FAX: 886-2-2515-8369